



5STP 21H4200

Old part no. TV 989-2100-42

Phase Control Thyristor

Properties

- High operational capability
- Possibility of serial and parallel connection

Applications

- Controlled rectifiers
- AC drives

Key Parameters

V_{DRM}, V_{RRM}	= 4 200	V
I_{TAVm}	= 2 192	A
I_{TSM}	= 32 000	A
V_{TO}	= 1.249	V
r_T	= 0.191	mΩ

Types

	V_{RRM}, V_{DRM}
5STP 21H4200	4 200 V
5STP 21H3600	3 600 V
Conditions:	$T_j = -40 \div 125 \text{ }^\circ\text{C}$, half sine waveform, $f = 50 \text{ Hz}$, note 1

Mechanical Data

F_m	Mounting force	50 ± 5 kN
m	Weight	0.93 kg
D_s	Surface creepage distance	36 mm
D_a	Air strike distance	15 mm

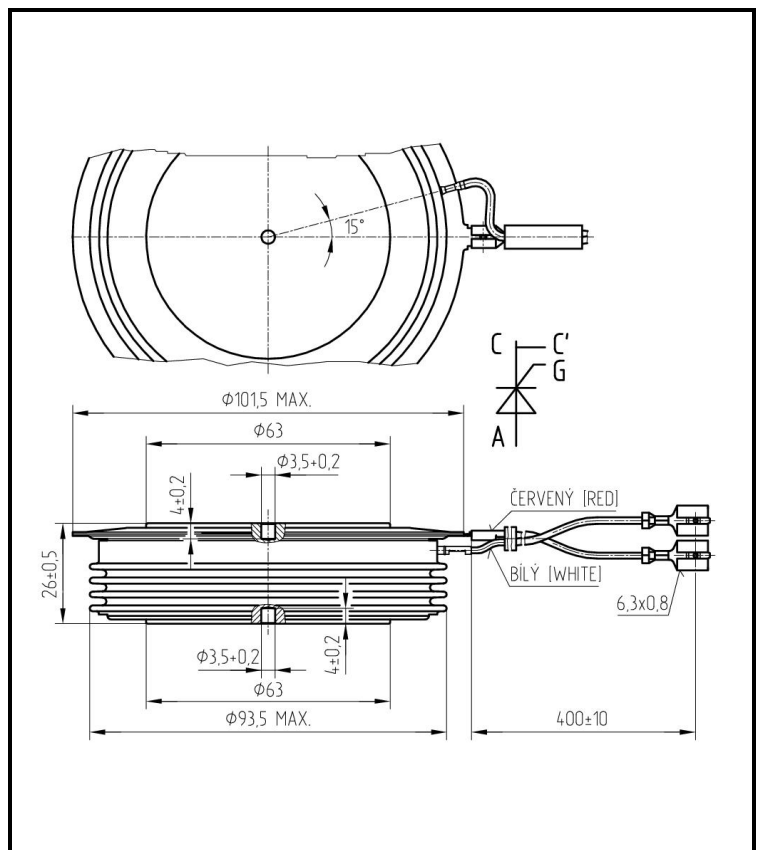

Fig. 1 Case

Maximum Ratings			Maximum Limits	Unit
V_{RRM} V_{DRM}	Repetitive peak reverse and off-state voltage $T_j = -40 \div 125 \text{ }^\circ\text{C}$, note 1	5STP 21H4200 5STP 21H3600	4 200 3 600	V
V_{RSM} V_{DSM}	Non-repetitive peak reverse and off-state voltage $T_j = 25 \div 125 \text{ }^\circ\text{C}$	5STP 21H4200 5STP 21H3600	4 300 3 700	V
I_{TRMS}	RMS on-state current $T_c = 70 \text{ }^\circ\text{C}$, half sine waveform, $f = 50 \text{ Hz}$		3 443	A
I_{TAVm}	Average on-state current $T_c = 70 \text{ }^\circ\text{C}$, half sine waveform, $f = 50 \text{ Hz}$		2 192	A
I_{TSM}	Peak non-repetitive surge half sine pulse, $V_R = 0 \text{ V}$	$t_p = 10 \text{ ms}$ $t_p = 8.3 \text{ ms}$	32 000 34 200	A
I^2t	Limiting load integral half sine pulse, $V_R = 0 \text{ V}$	$t_p = 10 \text{ ms}$ $t_p = 8.3 \text{ ms}$	5 120 000 4 850 000	A²s
$(di_T/dt)_{cr}$	Critical rate of rise of on-state current $I_T = I_{TAVm}$, half sine waveform, $f = 50 \text{ Hz}$, $V_D = 2/3 V_{DRM}$, $t_r = 0.3 \text{ } \mu\text{s}$, $I_{GT} = 2 \text{ A}$		150	A/μs
$(dv_D/dt)_{cr}$	Critical rate of rise of off-state voltage $V_D = 2/3 V_{DRM}$		1 000	V/μs
P_{GAVm}	Maximum average gate power losses		5	W
I_{FGM}	Peak gate current		10	A
V_{FGM}	Peak gate voltage		12	V
V_{RGM}	Reverse peak gate voltage		10	V
$T_{jmin} - T_{jmax}$	Operating temperature range		-40 \div 125	$^\circ\text{C}$
$T_{stgmin} - T_{stgmax}$	Storage temperature range		-40 \div 125	$^\circ\text{C}$

Unless otherwise specified $T_j = 125 \text{ }^\circ\text{C}$

Note 1: De-rating factor of 0.13% V_{RRM} or V_{DRM} per $^\circ\text{C}$ is applicable for T_j below $25 \text{ }^\circ\text{C}$

Characteristics		Value			Unit
		min.	typ.	max.	
V_{TM}	Maximum peak on-state voltage $I_{TM} = 4\ 000\ A$			2.030	V
V_{T0}	Threshold voltage			1.249	V
r_T	Slope resistance $I_{T1} = 3\ 299\ A, I_{T2} = 9\ 896\ A$			0.191	m Ω
I_{DM}	Peak off-state current $V_D = V_{DRM}$			200	mA
I_{RM}	Peak reverse current $V_R = V_{RRM}$			200	mA
t_{gd}	Delay time $T_j = 25\ ^\circ C, V_D = 0.4\ V_{DRM}, I_{TM} = I_{TAVm},$ $t_r = 0.3\ \mu s, I_{GT} = 2\ A$			3	μs
t_q	Turn-off time $I_T = 2\ 000\ A, di_T/dt = 12.5\ A/\mu s,$ $V_D = 2/3\ V_{DRM}, dv_D/dt = 50\ V/\mu s$		700		μs
Q_{rr}	Recovery charge the same conditions as at t_q		3 400		μC
I_H	Holding current	$T_j = 25\ ^\circ C$ $T_j = 125\ ^\circ C$	170 90		mA
I_L	Latching current	$T_j = 25\ ^\circ C$ $T_j = 125\ ^\circ C$	1 500 1 000		mA
V_{GT}	Gate trigger voltage $V_D = 12V, I_T = 4\ A$	$T_j = -40\ ^\circ C$ $T_j = 25\ ^\circ C$ $T_j = 125\ ^\circ C$	0.25	4 3 2	V
I_{GT}	Gate trigger current $V_D = 12V, I_T = 4\ A$	$T_j = -40\ ^\circ C$ $T_j = 25\ ^\circ C$ $T_j = 125\ ^\circ C$	10	500 300 200	mA

Unless otherwise specified $T_j = 125\ ^\circ C$

Thermal Parameters		Value	Unit
R_{thjc}	Thermal resistance junction to case double side cooling	10.0	K/kW
	anode side cooling	16.0	
	cathode side cooling	26.5	
R_{thch}	Thermal resistance case to heatsink double side cooling	3.0	K/kW
	single side cooling	6.0	

Transient Thermal Impedance

Analytical function for transient thermal impedance

$$Z_{thjc} = \sum_{i=1}^5 R_i (1 - \exp(-t/\tau_i))$$

Conditions:

$F_m = 50 \pm 5$ kN, Double side cooled

Correction for periodic waveforms

- 180° sine: add 1.0 K/kW
- 180° rectangular: add 1.0 K/kW
- 120° rectangular: add 1.5 K/kW
- 60° rectangular: add 3.0 K/kW

i	1	2	3	4	5
τ_i (s)	0.4871	0.1468	0.0677	0.0079	0.0021
R_i (K/kW)	6.73	1.44	0.65	0.84	0.32

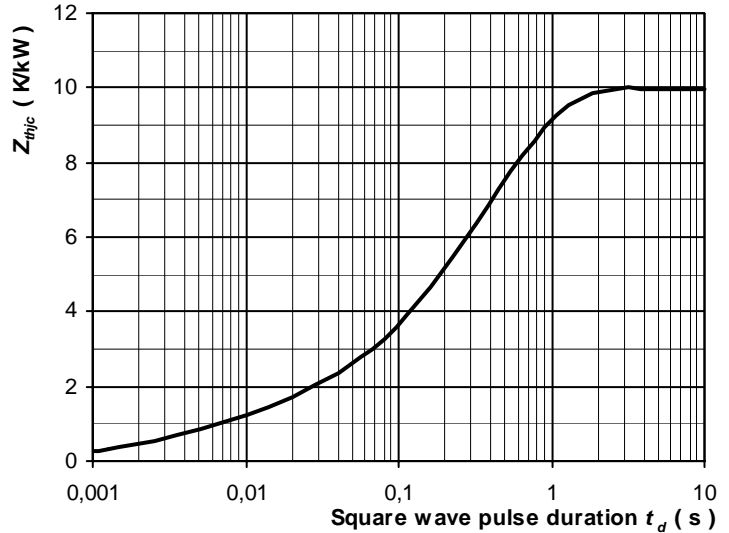

Fig. 2 Dependence transient thermal impedance junction to case on square pulse

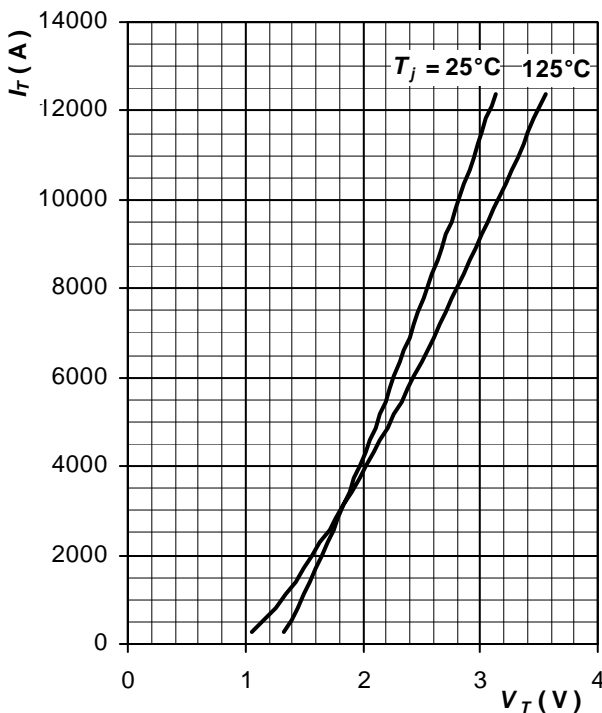

Fig. 3 Maximum on-state characteristics

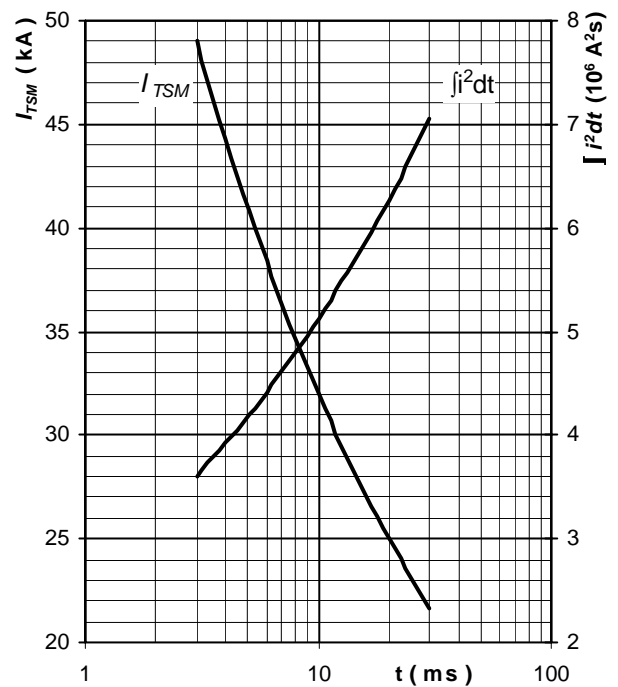

Fig. 4 Surge on-state current vs. pulse length, half sine wave, single pulse, $V_R = 0$ V, $T_j = T_{jmax}$

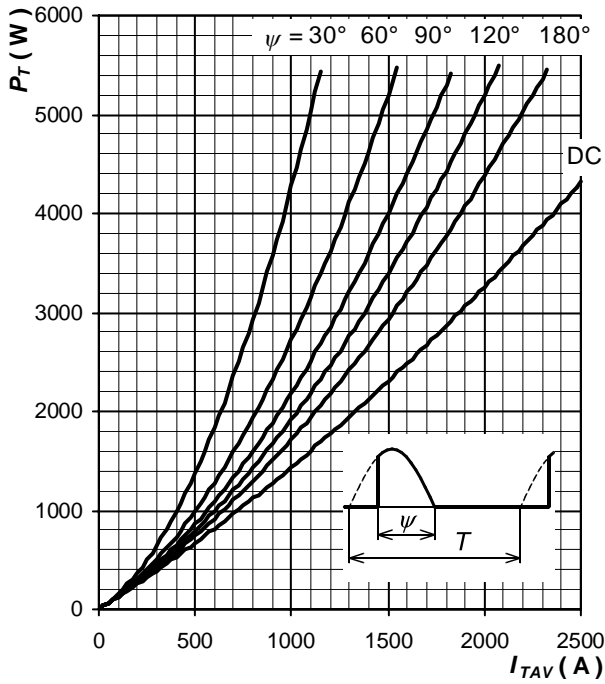

Fig. 5 On-state power loss vs. average on-state current, sine waveform, $f = 50 \text{ Hz}$, $T = 1/f$

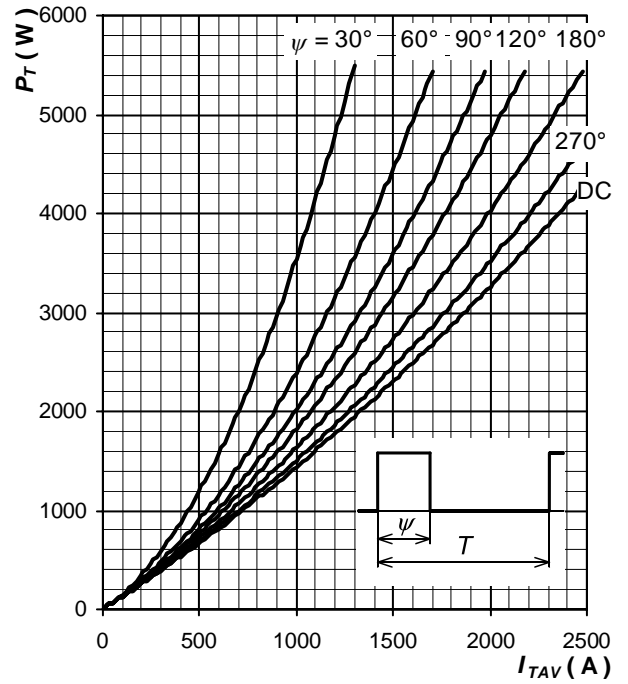

Fig. 6 On-state power loss vs. average on-state current, square waveform, $f = 50 \text{ Hz}$, $T = 1/f$

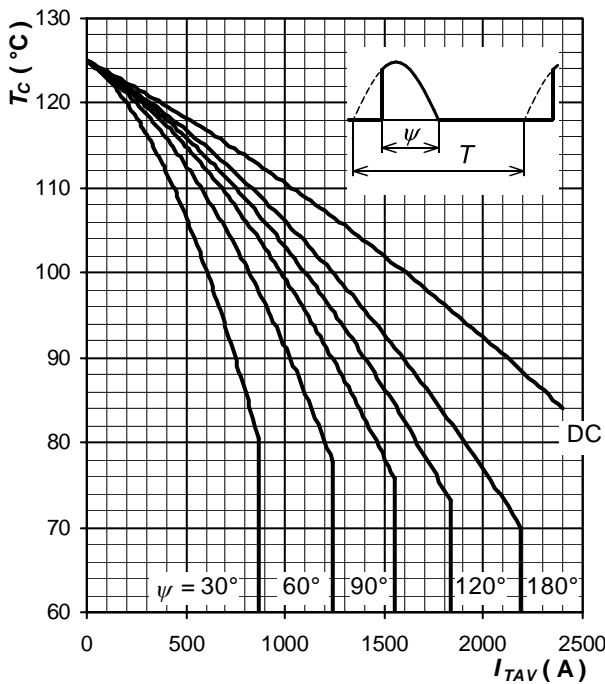

Fig. 7 Max. case temperature vs. aver. on-state current, sine waveform, $f = 50 \text{ Hz}$, $T = 1/f$

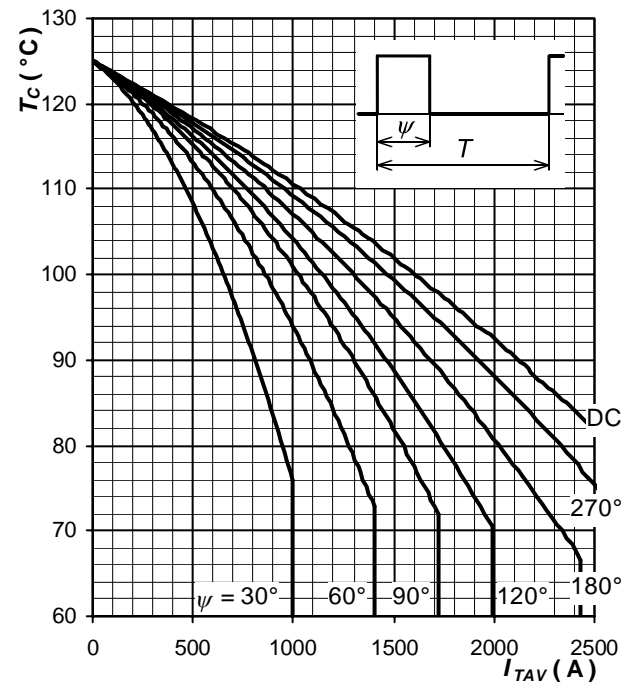

Fig. 8 Max. case temperature vs. aver. on-state current, square waveform, $f = 50 \text{ Hz}$, $T = 1/f$

Notes: