

V_{DSM}	=	6500 V
I_{TAVM}	=	1800 A
I_{TRMS}	=	2820 A
I_{TSM}	=	32000 A
V_{T0}	=	1.20 V
r_T	=	0.430 m Ω

Phase Control Thyristor

5STP 18M6500

Doc. No. 5SYA1010-03 Sep. 01

- Patented free-floating silicon technology
- Low on-state and switching losses
- Designed for traction, energy and industrial applications
- Optimum power handling capability
- Interdigitated amplifying gate

Blocking

Part Number	5STP	5STP 18M6200	5STP 18M5800	Conditions
V_{DSM} V_{RSM}	6500 V	6200 V	5800 V	$f = 5$ Hz, $t_p = 10$ ms
V_{DRM} V_{RRM}	5600 V	5300 V	4900 V	$f = 50$ Hz, $t_p = 10$ ms
V_{RSM1}	7000 V	6700 V	6300 V	$t_p = 5$ ms, single pulse
I_{DSM}	≤ 600 mA			V_{DSM}
I_{RSM}	≤ 600 mA			V_{RSM}
dV/dt_{crit}	2000 V/ μ s			Exp. to $0.67 \times V_{DRM}$, $T_j = 125^\circ\text{C}$

V_{DRM}/V_{RRM} are equal to V_{DSM}/V_{RSM} values up to $T_j = 110^\circ\text{C}$

Mechanical data

F_M	Mounting force	nom.	70 kN
		min.	63 kN
		max.	84 kN
a	Acceleration		
	Device unclamped		50 m/s ²
	Device clamped		100 m/s ²
m	Weight		1.85 kg
D_S	Surface creepage distance		45 mm
D_a	Air strike distance		21 mm



ABB Semiconductors AG reserves the right to change specifications without notice.

On-state

I_{TAVM}	Max. average on-state current	1800 A	Half sine wave, $T_C = 70^\circ\text{C}$	
I_{TRMS}	Max. RMS on-state current	2820 A		
I_{TSM}	Max. peak non-repetitive	32000 A	$t_p = 10\text{ ms}$	$T_j = 125^\circ\text{C}$
	surge current	35000 A	$t_p = 8.3\text{ ms}$	After surge:
I^2t	Limiting load integral	5120 kA^2s	$t_p = 10\text{ ms}$	$V_D = V_R = 0\text{V}$
		5000 kA^2s	$t_p = 8.3\text{ ms}$	
V_T	On-state voltage	1.90 V	$I_T = 1600\text{ A}$	$T_j = 125^\circ\text{C}$
V_{T0}	Threshold voltage	1.20 V	$I_T = 1000 - 3000\text{ A}$	
r_T	Slope resistance	0.430 $\text{m}\Omega$		
I_H	Holding current	50-125 mA	$T_j = 25^\circ\text{C}$	
		20-75 mA	$T_j = 125^\circ\text{C}$	
I_L	Latching current	100- mA	$T_j = 25^\circ\text{C}$	
		75-250 mA	$T_j = 125^\circ\text{C}$	

Switching

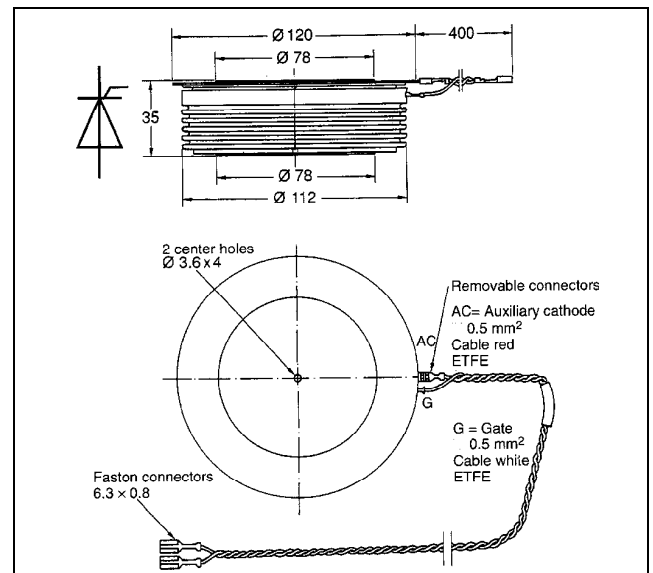
di/dt_{crit}	Critical rate of rise of on-state current	250 A/ μs	Cont. $f = 50\text{ Hz}$	$V_D \leq 0.67 \cdot V_{DRM}$, $T_j = 125^\circ\text{C}$ $I_{TRM} = 2000\text{ A}$ $I_{FG} = 2\text{ A}$, $t_r = 0.5\text{ }\mu\text{s}$
		500 A/ μs	60 sec. $f = 50\text{ Hz}$	
t_d	Delay time	$\leq 3.0\text{ }\mu\text{s}$	$V_D = 0.4 \cdot V_{DRM}$	$I_{FG} = 2\text{ A}$, $t_r = 0.5\text{ }\mu\text{s}$
t_q	Turn-off time	$\leq 800\text{ }\mu\text{s}$	$V_D \leq 0.67 \cdot V_{DRM}$ $dv_D/dt = 20\text{ V}/\mu\text{s}$	$I_{TRM} = 2000\text{ A}$, $T_j = 125^\circ\text{C}$ $V_R > 200\text{ V}$, $di_T/dt = -1\text{ A}/\mu\text{s}$
Q_{rr}	Recovery charge	min	2000 μAs	
		max	3000 μAs	

Triggering

V_{GT}	Gate trigger voltage	2.6 V	$T_j = 25^\circ$
I_{GT}	Gate trigger current	400 mA	$T_j = 25^\circ$
V_{GD}	Gate non-trigger voltage	0.3 V	$V_D = 0.4 \times V_{DRM}$
I_{GD}	Gate non-trigger current	10 mA	$V_D = 0.4 \times V_{DRM}$
V_{FGM}	Peak forward gate voltage	12 V	
I_{FGM}	Peak forward gate current	10 A	
V_{RGM}	Peak reverse gate voltage	10 V	
P_G	Gate power loss	3 W	

Thermal

T_{jmax}	Max. operating junction temperature range	125 °C	
T_{stg}	Storage temperature range	-40...140 °C	
R_{thJC}	Thermal resistance junction to case	18 K/kW	Anode side cooled
		18 K/kW	Cathode side cooled
		9 K/kW	Double side cooled
R_{thCH}	Thermal resistance case to heat sink	3 K/kW	Single side cooled
		1.5 K/kW	Double side cooled

Analytical function for transient thermal impedance:

$$Z_{thJC}(t) = \sum_{i=1}^n R_i(1 - e^{-t/\tau_i})$$

i	1	2	3	4
R_i (K/kW)	6.28	1.07	1.09	0.52
τ_i (s)	0.8956	0.1606	0.0256	0.0093

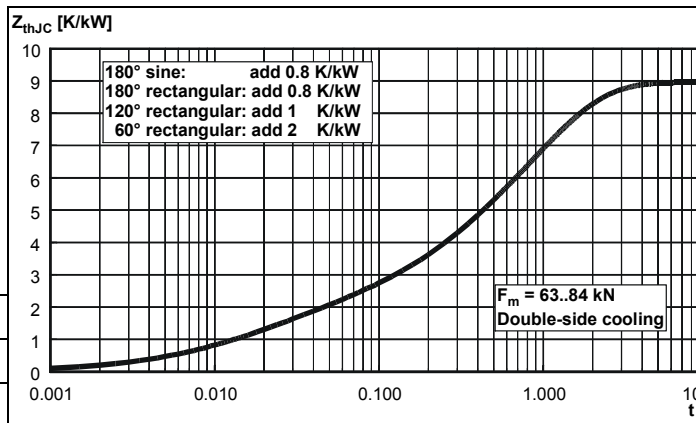

Fig. 1 Transient thermal impedance junction to case.

On-state characteristic model:

$$V_T = A + B \cdot i_T + C \cdot \ln(i_T + 1) + D \cdot \sqrt{i_T}$$

Valid for $i_T = 400 - 6000$ A

A	B	C	D
0.871422	0.000093	-0.020798	0.025657

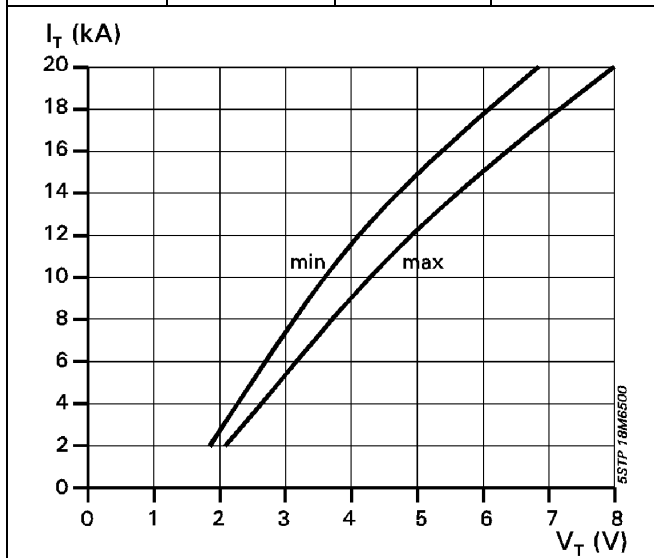

Fig. 2 On-state characteristics. $T_j=125^\circ\text{C}$, 10ms half sine

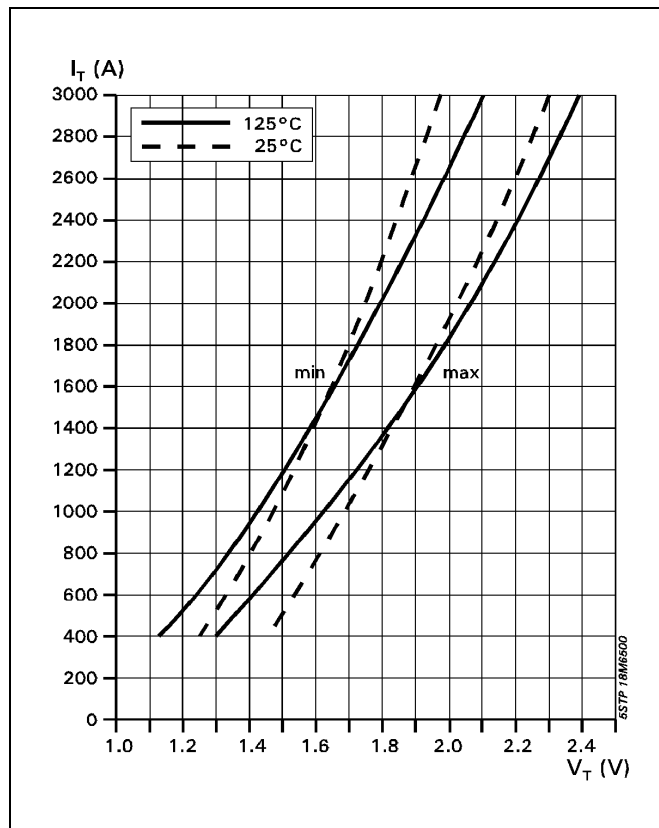

Fig. 3 On-state characteristics.

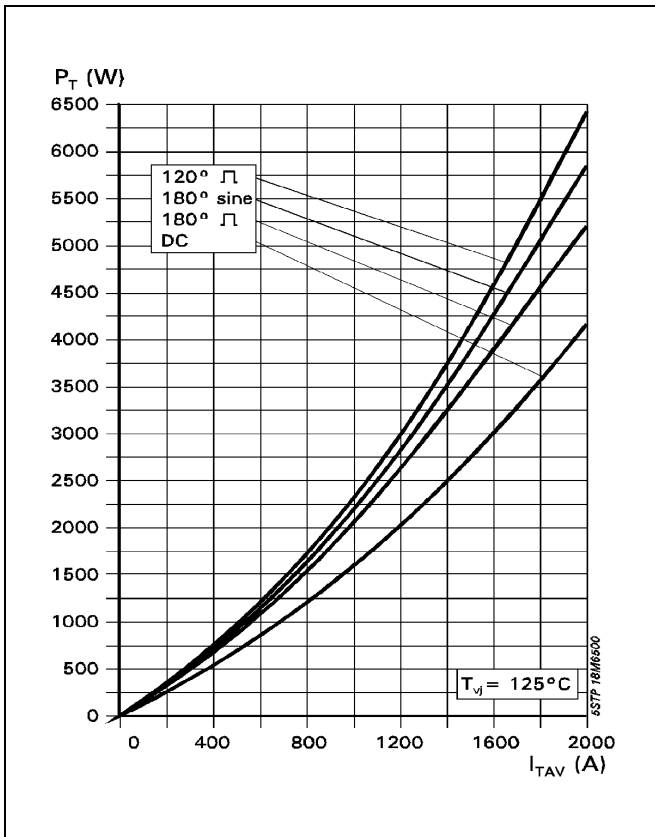

Fig. 4 On-state power dissipation vs. mean on-state current. Turn - on losses excluded.

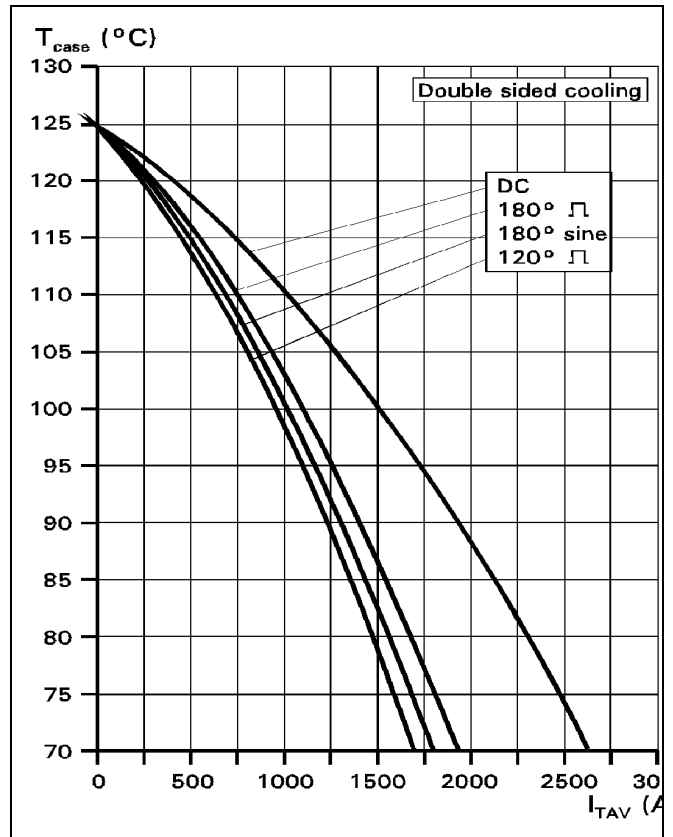

Fig. 5 Max. permissible case temperature vs. mean on-state current.

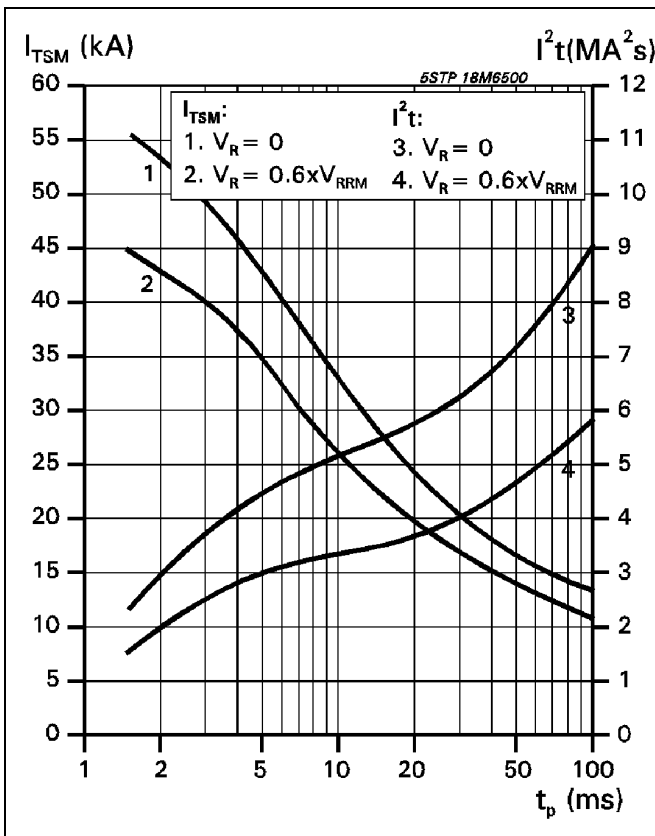

Fig. 6 Surge on-state current vs. pulse length. Half-sine wave.

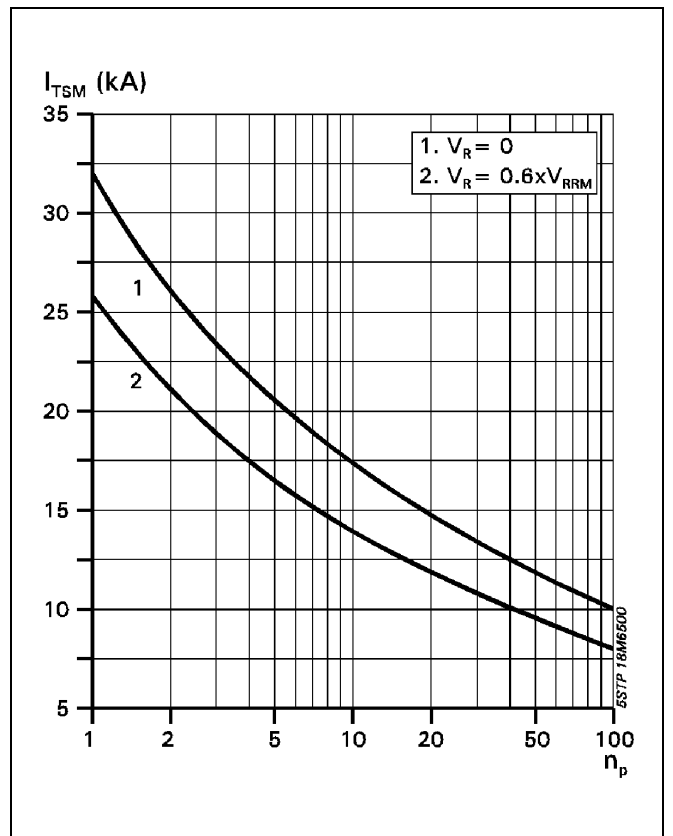

Fig. 7 Surge on-state current vs. number of pulses. Half-sine wave, 10 ms, 50Hz.

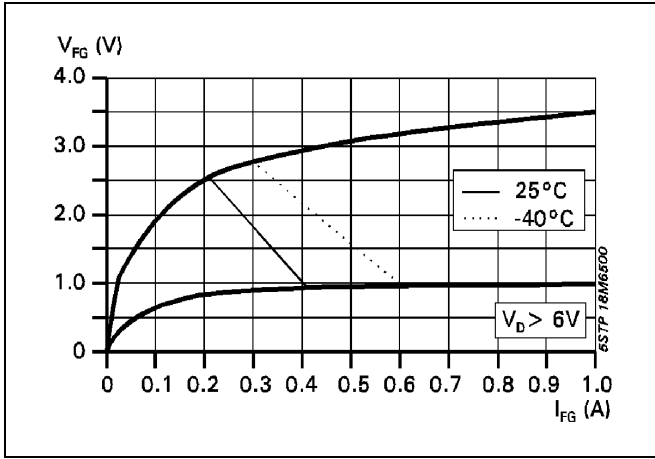

Fig. 8 Gate trigger characteristics.

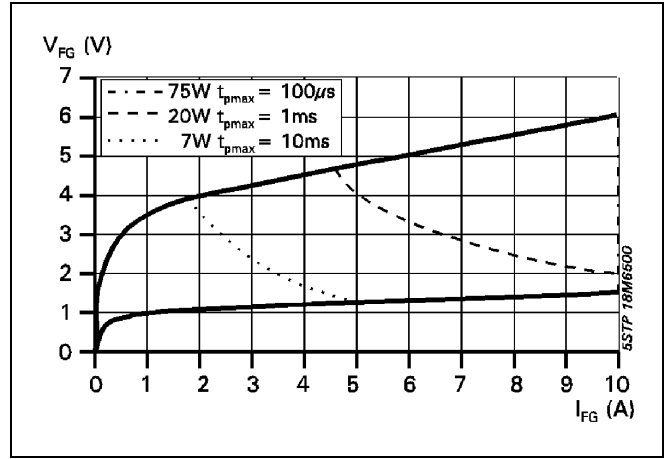

Fig. 9 Max. peak gate power loss.

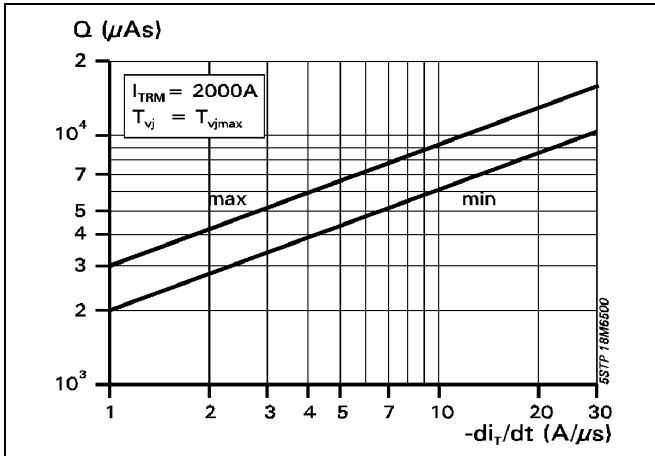

Fig. 10 Recovery charge vs. decay rate of on-state current.

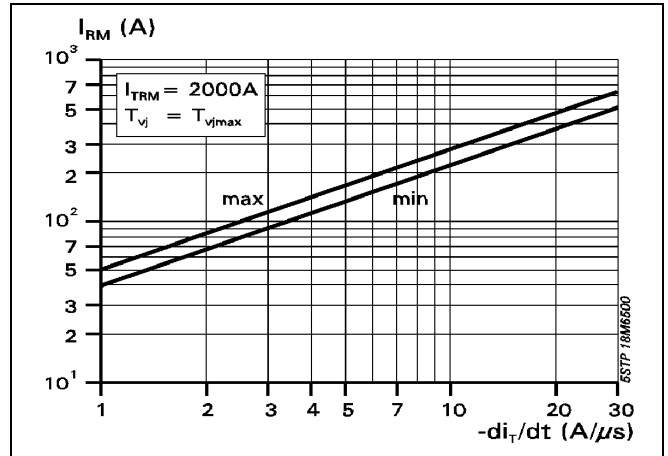

Fig. 11 Peak reverse recovery current vs. decay rate of on-state current.

Turn - off time, typical parameter relationship.

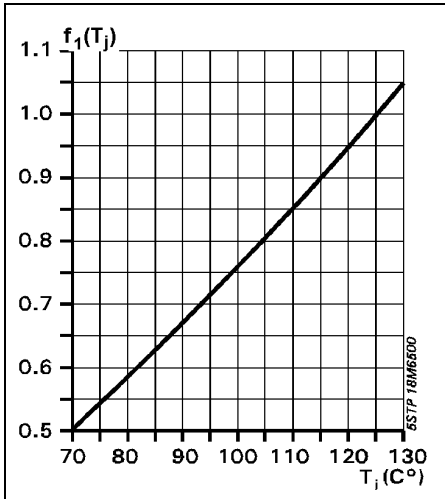

Fig. 12 $t_q/t_{q1} = f_1(T_j)$

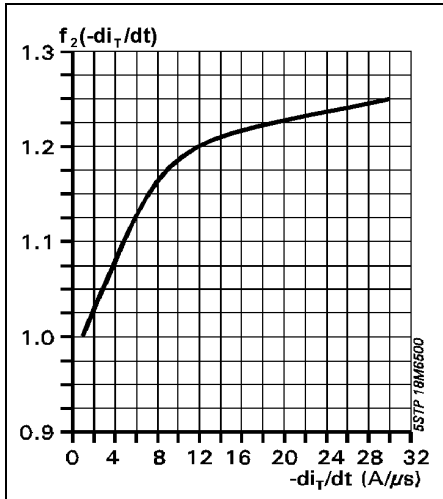

Fig. 13 $t_q/t_{q1} = f_2(-di_T/dt)$

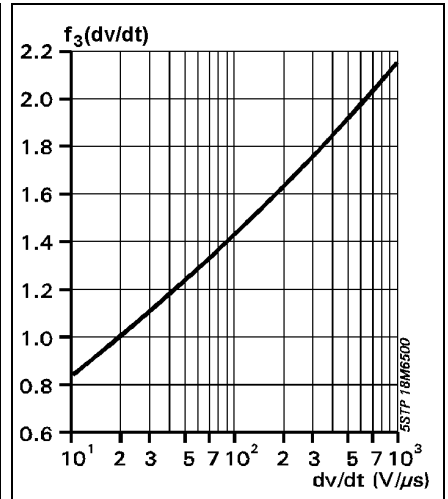

Fig. 14 $t_q/t_{q1} = f_3(dv/dt)$

$t_q = t_{q1} \cdot f_1(T_j) \cdot f_2(-di_T/dt) \cdot f_3(dv/dt)$

t_{q1} : at normalized values (see page 2)
 t_q : at varying conditions

Turn-on and Turn-off losses

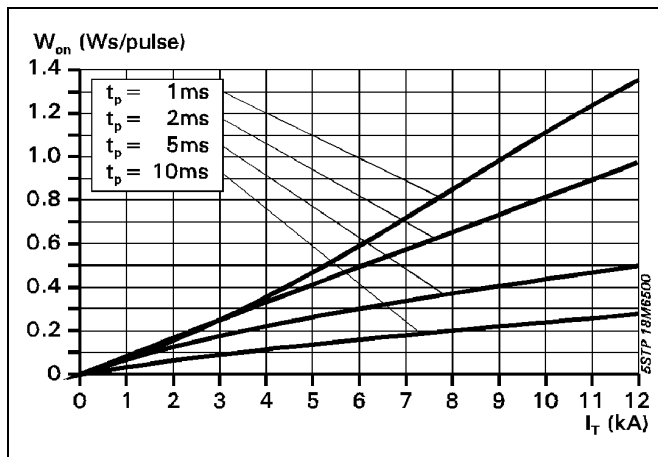

Fig. 15 $W_{on} = f(I_T, t_p)$, $T_j = 125^\circ\text{C}$.
Half sinusoidal waves.

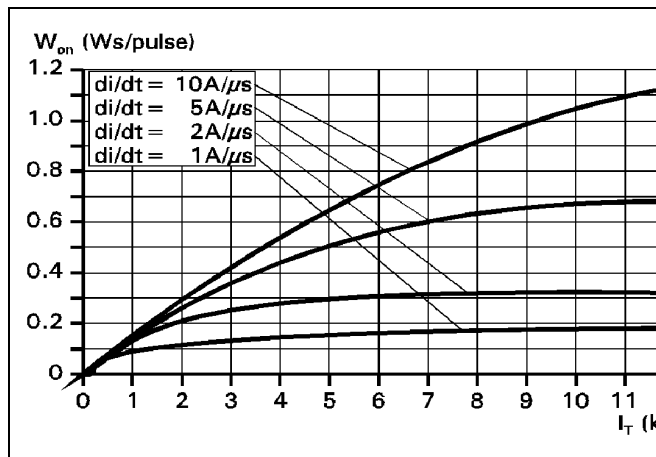

Fig. 16 $W_{on} = f(I_T, di/dt)$, $T_j = 125^\circ\text{C}$.
Rectangular waves.

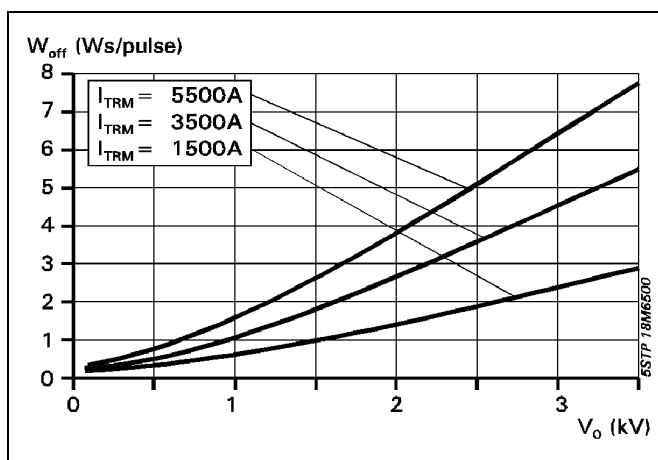

Fig. 17 $W_{off} = f(V_o, I_T)$, $T_j = 125^\circ\text{C}$.
Half sinusoidal waves. $t_p = 10$ ms.

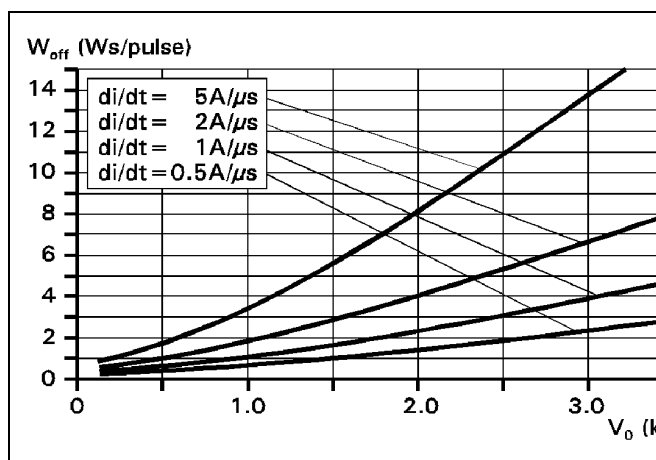

Fig. 18 $W_{off} = f(V_o, di/dt)$, $T_j = 125^\circ\text{C}$.
Rectangular waves.



ABB Semiconductors AG reserves the right to change specifications without notice.



ABB Semiconductors AG
 Fabrikstrasse 3
 CH-5600 Lenzburg, Switzerland

Doc. No. 5SYA1010-03 Sep. 01

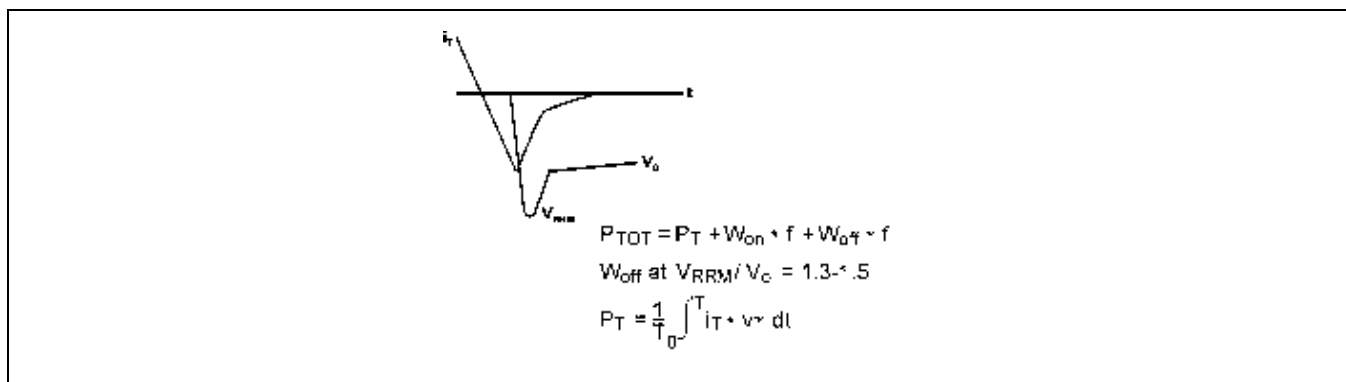
Telephone +41 (0)62 888 6419
 Fax +41 (0)62 888 6306
 Email abbsem@ch.abb.com
 Internet www.abbsem.com