



5STF 07T1414

Old part no. TR 907FC-740-14

Medium Frequency Thyristor

Properties

- § Amplifying gate
- § High operational capability
- § Optimized turn-on and turn-off parameters
- § High operating frequency

Applications

- § Power switching applications

Key Parameters

V_{DRM}, V_{RRM}	= 1 400	V
I_{TAV}	= 736	A
I_{TSM}	= 12.0	kA
V_{TO}	= 1.683	V
r_T	= 0.274	m Ω
t_q	= 12.5	μ s

Types

	V_{RRM}, V_{DRM}
5STF 07T1414..1417	1 400 V
5STF 07T1214..1217	1 200 V

Conditions:
 $T = -40 \div 125$ °C, half sine waveform,
 $f = 50$ Hz, note 1

Mechanical Data

F_m	Mounting force	10 \pm 2 kN
m	Weight	0.20 kg
D_s	Surface creepage distance	13 mm
D_a	Air strike distance	8 mm

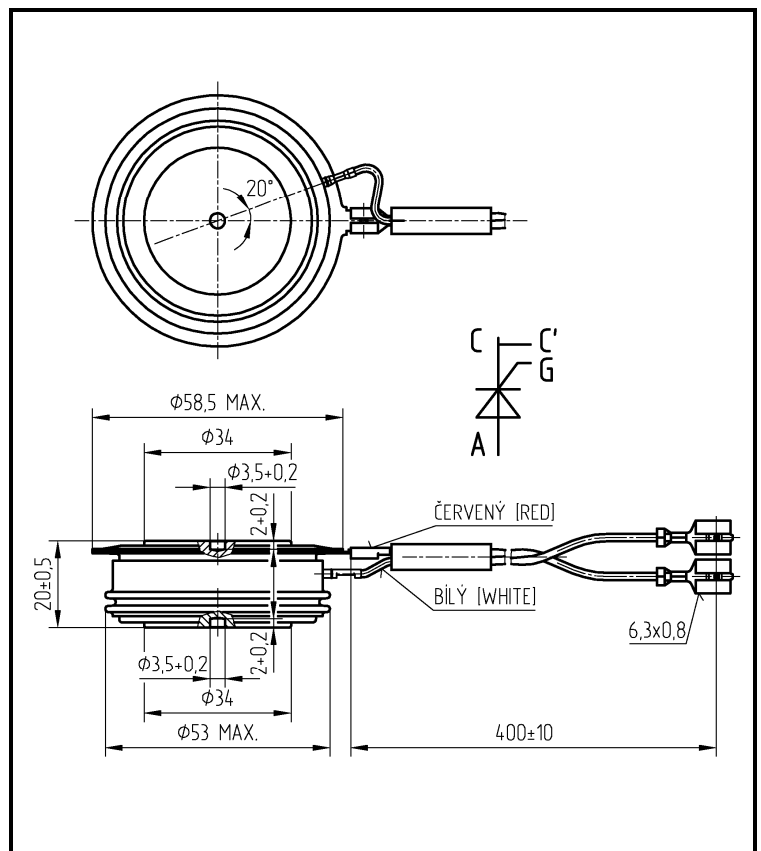

Fig. 1 Case



ABB s.r.o.

Novodvorska 1768/138a, 142 21 Praha 4, Czech Republic

tel.: +420 261 306 250, <http://www.abb.com/semiconductors>

Maximum Ratings			Maximum Limits	Unit
V_{RRM} V_{DRM}	Repetitive peak reverse and off-state voltage $T_j = -40 \div 125 \text{ }^\circ\text{C}$, note 1	5STF 07T1414..1417 5STF 07T1214..1217	1 400 1 200	V
I_{TRMS}	RMS on-state current $T_c = 70 \text{ }^\circ\text{C}$, half sine waveform, $f = 50 \text{ Hz}$		1 156	A
I_{TAVm}	Average on-state current $T_c = 70 \text{ }^\circ\text{C}$, half sine waveform, $f = 50 \text{ Hz}$		736	A
I_{TSM}	Peak non-repetitive surge half sine pulse, $V_R = 0 \text{ V}$	$t_p = 10 \text{ ms}$ $t_p = 8.3 \text{ ms}$	12 000 12 800	A
$\int i^2 t$	Limiting load integral half sine pulse, $V_R = 0 \text{ V}$	$t_p = 10 \text{ ms}$ $t_p = 8.3 \text{ ms}$	720 000 682 000	A ² s
$(di_T/dt)_{cr}$	Critical rate of rise of on-state current $I_T = I_{TAVm}$, half sine waveform, $f = 50 \text{ Hz}$, $V_D = 2/3 V_{DRM}$, $t_r = 0.3 \text{ } \mu\text{s}$, $I_{GT} = 2 \text{ A}$		800	A/ μs
$(dv_D/dt)_{cr}$	Critical rate of rise of off-state voltage $V_D = 2/3 V_{DRM}$		1 000	V/ μs
P_{GAVm}	Maximum average gate power losses		3	W
I_{FGM}	Peak gate current		10	A
V_{FGM}	Peak gate voltage		12	V
V_{RGM}	Reverse peak gate voltage		10	V
$T_{jmin} - T_{jmax}$	Operating temperature range		-40 \div 125	$^\circ\text{C}$
$T_{stgmin} - T_{stgmax}$	Storage temperature range		-40 \div 125	$^\circ\text{C}$

Unless otherwise specified $T_j = 125 \text{ }^\circ\text{C}$

Note 1: De-rating factor of 0.13% V_{RRM} or V_{DRM} per $^\circ\text{C}$ is applicable for T_j below $25 \text{ }^\circ\text{C}$

Characteristics		Value			Unit
		min.	typ.	max.	
V_{TM}	Maximum peak on-state voltage $I_{TM} = 1\ 500\ A$			2.100	V
V_{T0}	Threshold voltage			1.683	V
r_T	Slope resistance $I_{T1} = 1\ 162\ A, I_{T2} = 3\ 487\ A$			0.274	mW
I_{DM}	Peak off-state current $V_D = V_{DRM}$			70	mA
I_{RM}	Peak reverse current $V_R = V_{RRM}$			70	mA
t_{gd}	Delay time $T_j = 25\ ^\circ C, V_D = 0.4\ V_{DRM}, I_{TM} = I_{TAVm},$ $t_r = 0.3\ \mu s, I_{GT} = 2\ A$			2.0	μs
t_{q1}	Turn-off time $I_T = 500\ A, di_T/dt = -50\ A/\mu s,$ $V_R = 100\ V, V_D = 2/3\ V_{DRM},$ $dv_D/dt = 50\ V/\mu s$	group of t_q 5STF 07T1414 5STF 07T1214 5STF 07T1417 5STF 07T1217		12.5 16.0	μs
Q_{rr}	Recovery charge <i>the same conditions as at t_{q1}</i>			160	μC
I_{rrM}	Reverse recovery current <i>the same conditions as at t_{q1}</i>			100	A
I_H	Holding current	$T_j = 25\ ^\circ C$ $T_j = 125\ ^\circ C$		250 150	mA
I_L	Latching current	$T_j = 25\ ^\circ C$ $T_j = 125\ ^\circ C$		1 500 1 000	mA
V_{GT}	Gate trigger voltage $V_D = 12V, I_T = 4\ A$	$T_j = -40\ ^\circ C$ $T_j = 25\ ^\circ C$ $T_j = 125\ ^\circ C$	0.25	4 3 2	V
I_{GT}	Gate trigger current $V_D = 12V, I_T = 4\ A$	$T_j = -40\ ^\circ C$ $T_j = 25\ ^\circ C$ $T_j = 125\ ^\circ C$	10	1000 500 300	mA

Unless otherwise specified $T_j = 125\ ^\circ C$

Thermal Parameters		Value	Unit
R_{thjc}	Thermal resistance junction to case <i>double side cooling</i>	32.0	K/kW
	<i>anode side cooling</i>	52.0	
	<i>cathode side cooling</i>	83.0	
R_{thch}	Thermal resistance case to heatsink <i>double side cooling</i>	10.0	K/kW
	<i>single side cooling</i>	20.0	

Transient Thermal Impedance

Analytical function for transient thermal impedance

$$Z_{thjc} = \sum_{i=1}^5 R_i (1 - \exp(-t/\tau_i))$$

Conditions:

$F_m = 10 \pm 2$ kN, Double side cooled

Correction for periodic waveforms

180° sine:	add 2.3 K/kW
180° rectangular:	add 3.1 K/kW
120° rectangular:	add 5.2 K/kW
60° rectangular:	add 8.7 K/kW

i	1	2	3	4	5
t_i (s)	0.4857	0.2162	0.0762	0.0043	0.0006
R_i (K/kW)	13.07	8.03	8.20	2.57	0.13

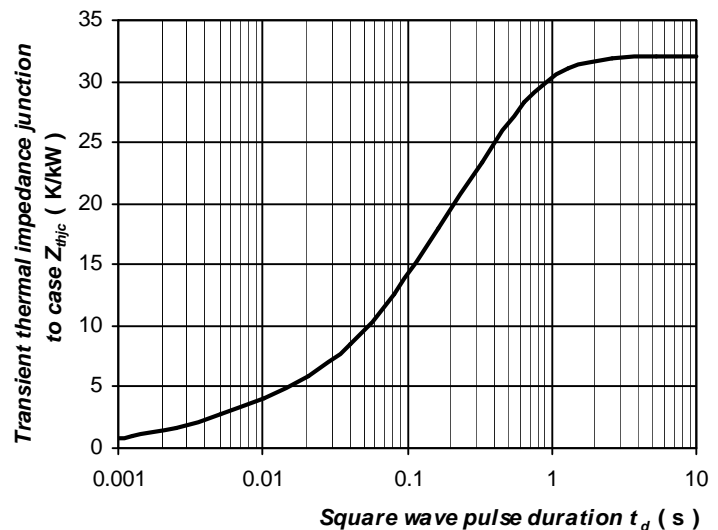

Fig. 2 Dependence transient thermal impedance junction to case on square pulse

On-State Characteristics

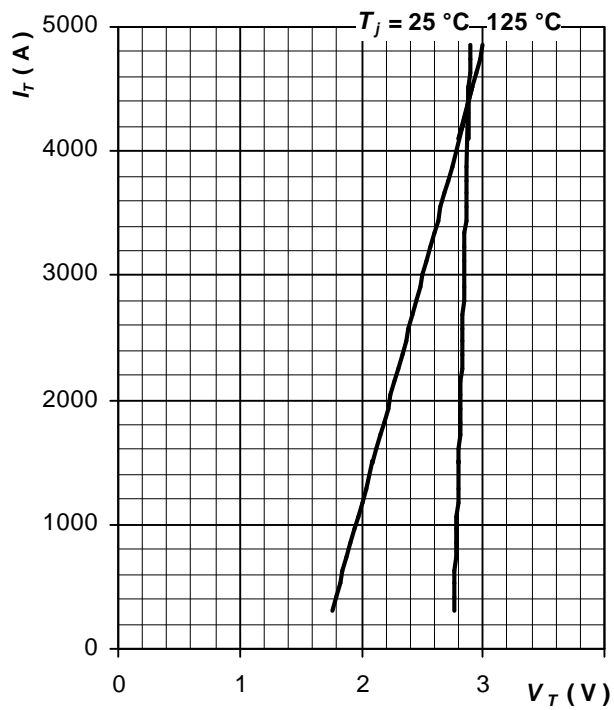

Fig. 3 Maximum on-state characteristics

Gate Trigger Characteristics

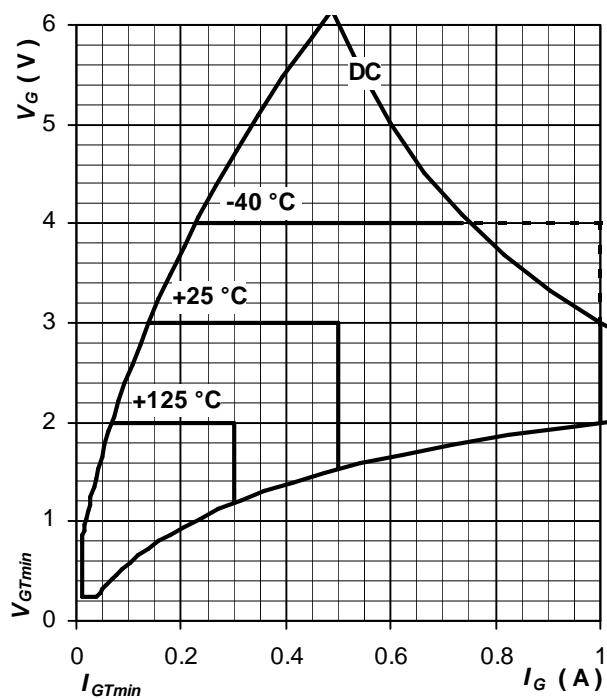

Fig. 4 Gate trigger characteristics

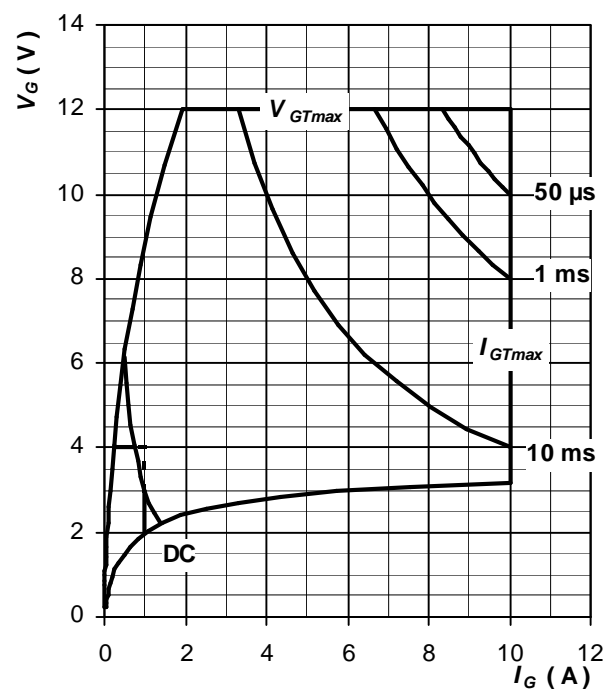

Fig. 5 Maximum peak gate power loss

Surge Characteristics

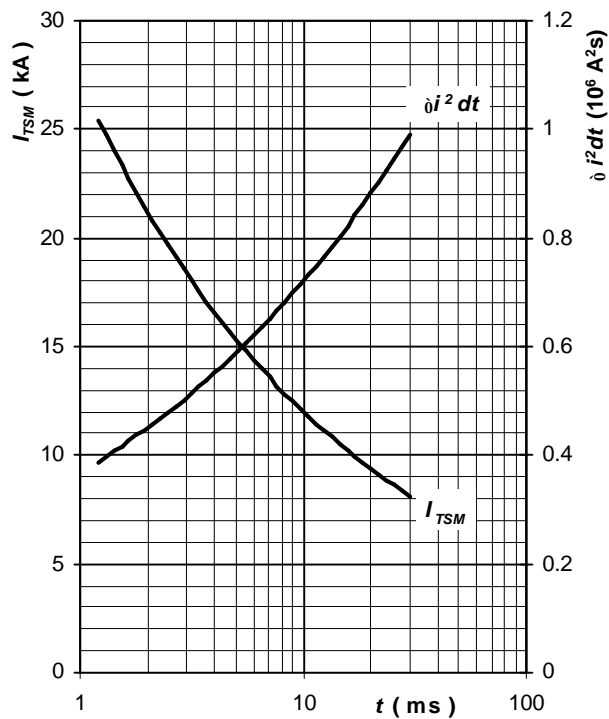

Fig. 6 Surge on-state current vs. pulse length, half sine wave, single pulse, $V_R = 0 \text{ V}$, $T_j = T_{jmax}$

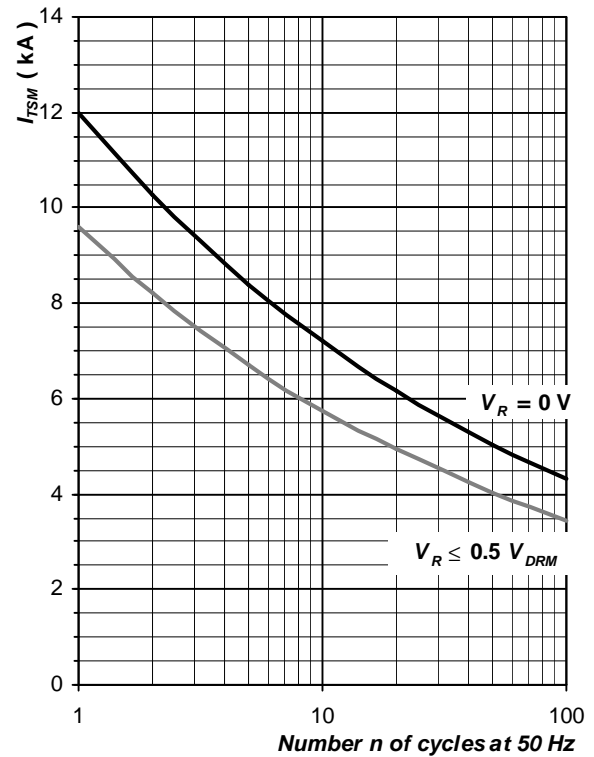

Fig. 7 Surge on-state current vs. number of pulses, half sine wave, $T_j = T_{jmax}$

Power Loss and Maximum Case Temperature Characteristics

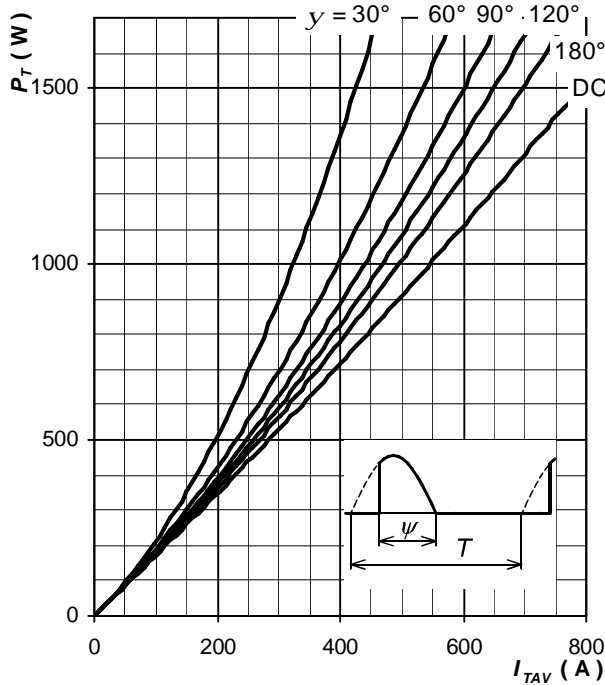

Fig. 8 On-state power loss vs. average on-state current, sine waveform, $f = 50 \text{ Hz}$, $T = 1/f$

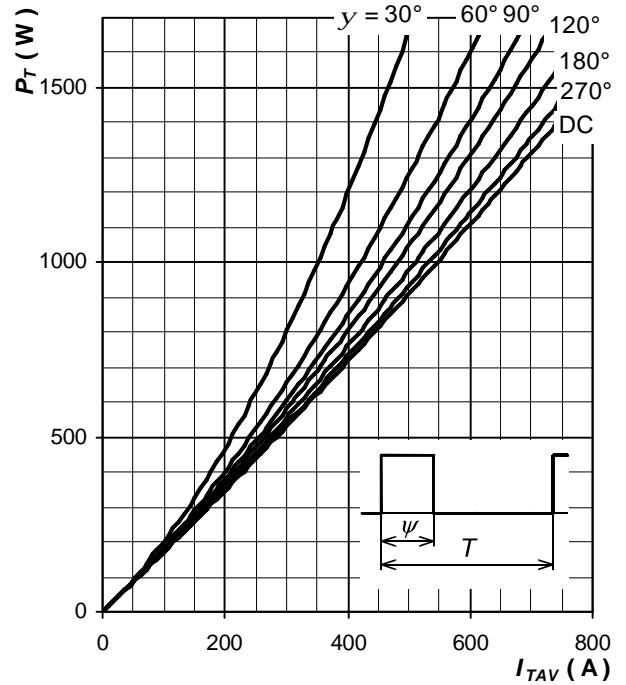

Fig. 9 On-state power loss vs. average on-state current, square waveform, $f = 50 \text{ Hz}$, $T = 1/f$

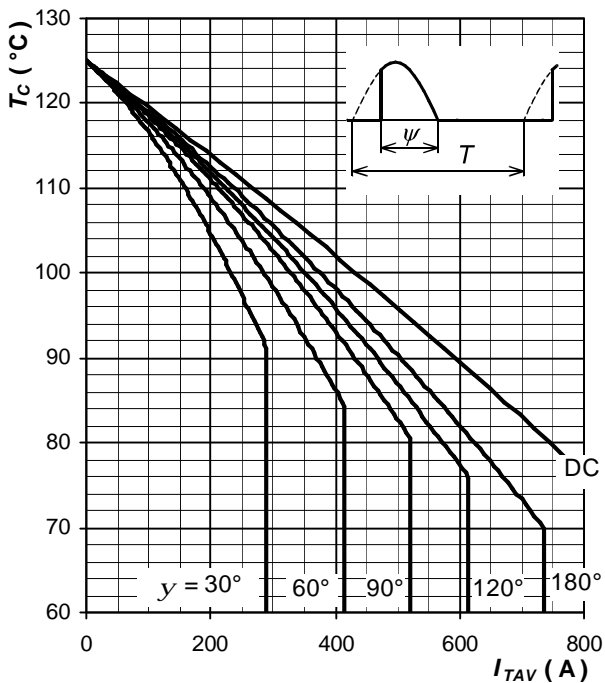

Fig. 10 Max. case temperature vs. aver. on-state current, sine waveform, $f = 50 \text{ Hz}$, $T = 1/f$

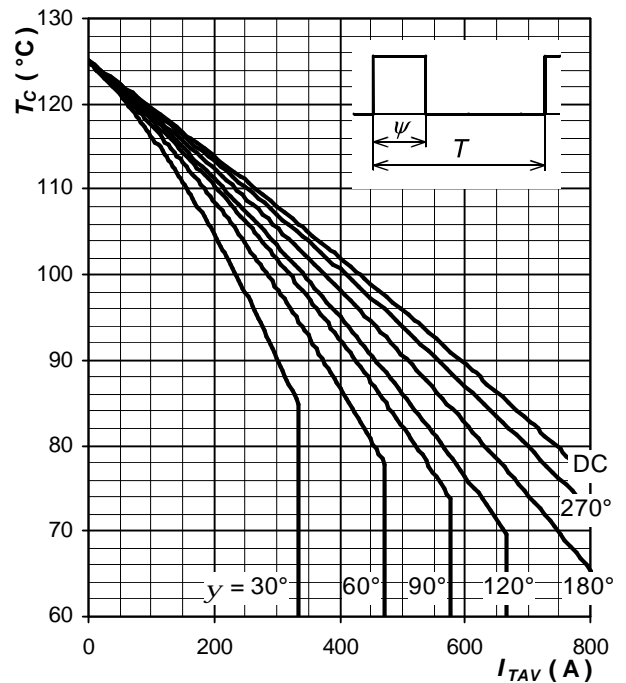

Fig. 11 Max. case temperature vs. aver. on-state current, square waveform, $f = 50 \text{ Hz}$, $T = 1/f$

Note 2: Figures number 8 , 11 have been calculated without considering any turn-on and turn-off losses. They are valid for $f = 50$ or 60 Hz operation.

Turn-off Time, Parameter Relationship

Maximum values of turn-off time at application specific conditions are given by using this formula:

$$t_q = t_{q1} \cdot \frac{t_q(T_j)}{t_{q1}} \cdot \frac{t_q(dv_D/dt)}{t_{q1}} \cdot \frac{t_q(-di_T/dt)}{t_{q1}}$$

where:

t_{q1} is turn-off time at standard conditions, see section "Characteristics"

$\frac{t_q(T_j)}{t_{q1}}$ is factor to be taken from fig. 12

$\frac{t_q(dv_D/dt)}{t_{q1}}$ is factor to be taken from fig. 13

$\frac{t_q(-di_T/dt)}{t_{q1}}$ is factor to be taken from fig. 14

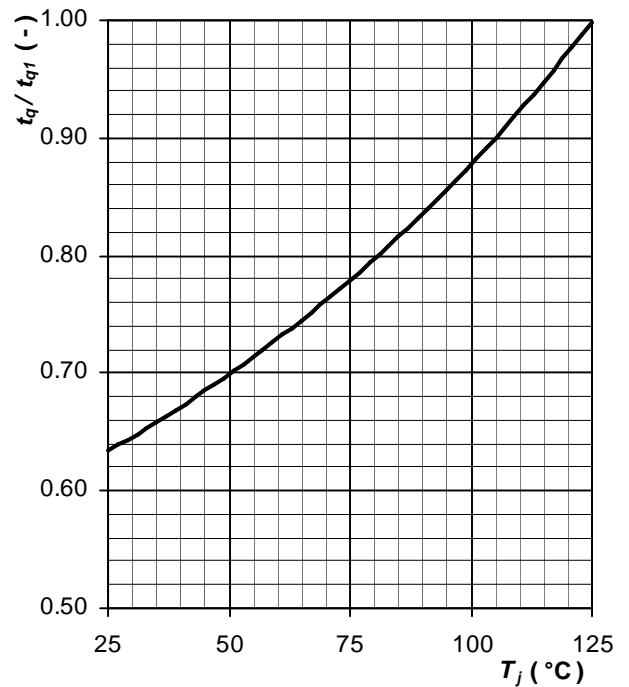

Fig. 12 Normalised maximum turn-off time vs. junction temperature

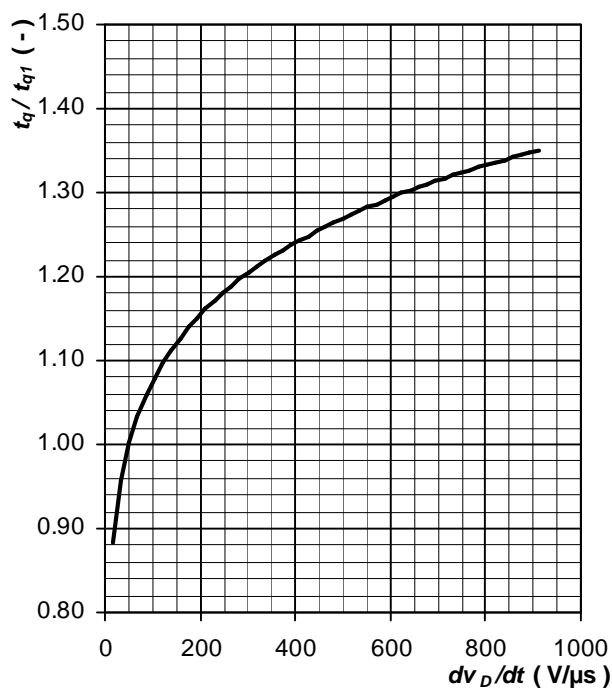

Fig. 13 Normalised maximum turn-off time vs. rate of rise of off-state voltage

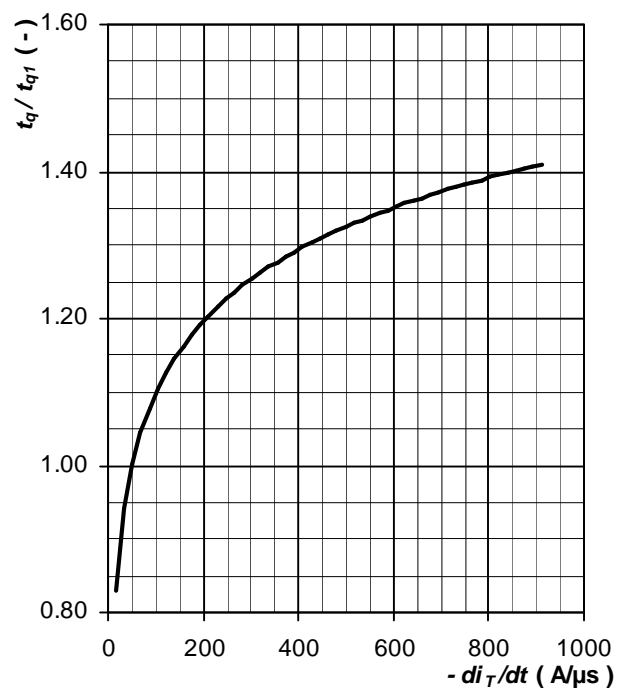

Fig. 14 Normalised maximum turn-off time vs. rate of fall of on-state current

Turn-on Characteristics



Fig. 15 Typical waveforms and definition of symbols at turn-on of a thyristor

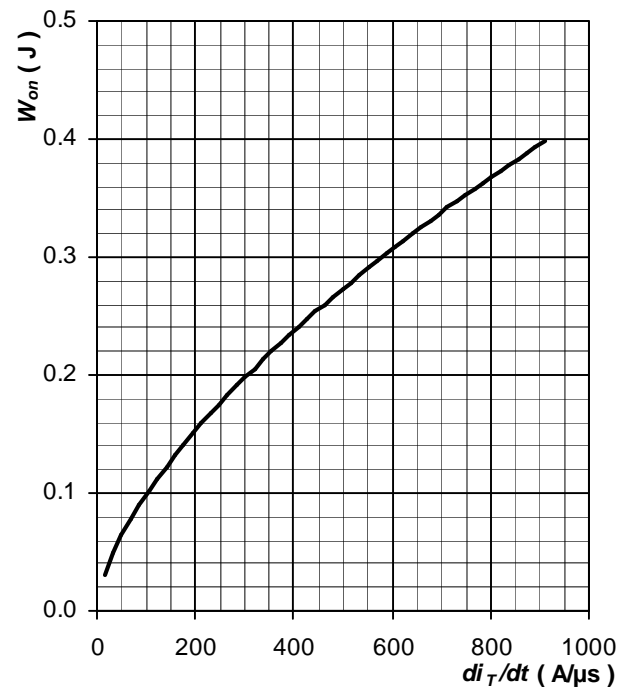

Fig. 16 Maximum turn-on energy per pulse vs. rate of rise on-state current, $T_j = T_{jmax}$

Turn-off Characteristics

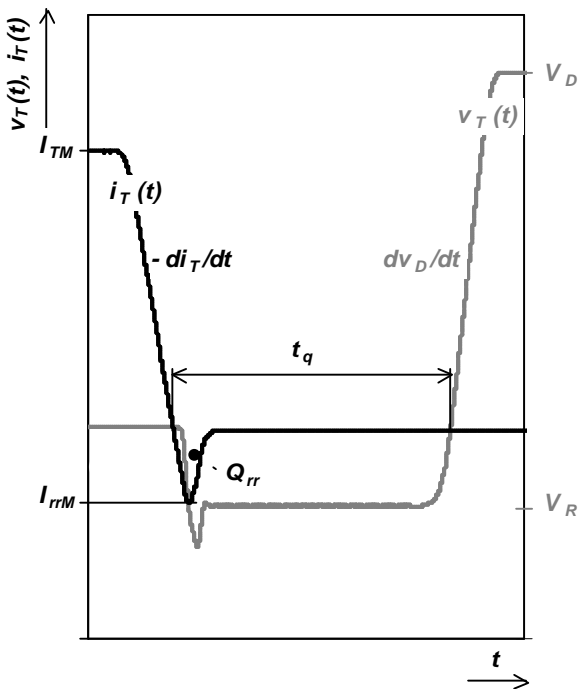

Fig. 17 Typical waveforms and definition of symbols at turn-off of a thyristor, inductive switching without RC snubber

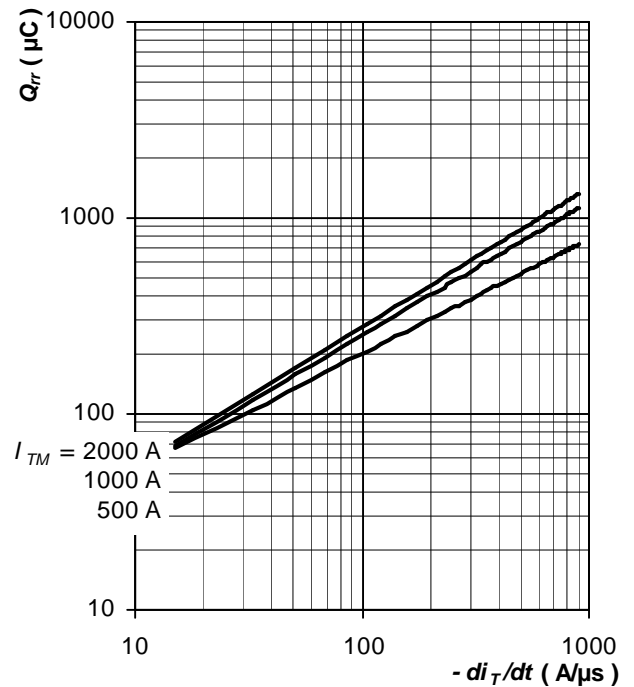

Fig. 18 Max. recovered charge vs. rate of fall on-state current, trapezoid pulse, $V_R = 100 \text{ V}$, $T_j = T_{jmax}$

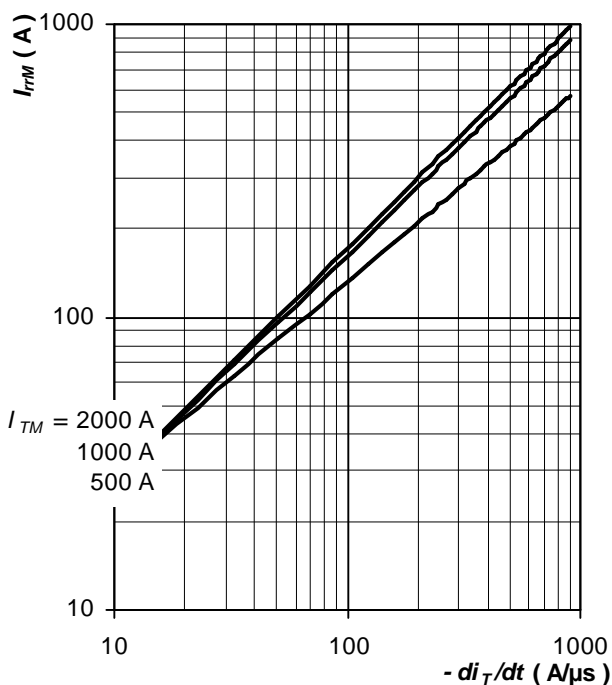

Fig. 19 Max. reverse recovery current vs. rate of fall on-state current, trapezoid pulse, $V_R = 100 \text{ V}$, $T_j = T_{jmax}$

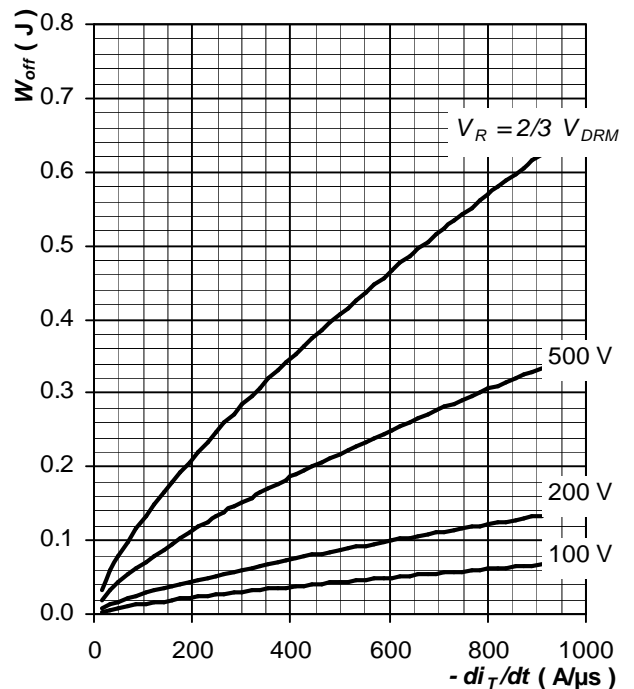

Fig. 20 Maximum turn-off energy per pulse vs. rate of fall on-state current, trapezoid pulse, inductive switching without RC snubber, $I_{TM} = 2\ 000 \text{ A}$, $T_j = T_{jmax}$

Frequency Ratings

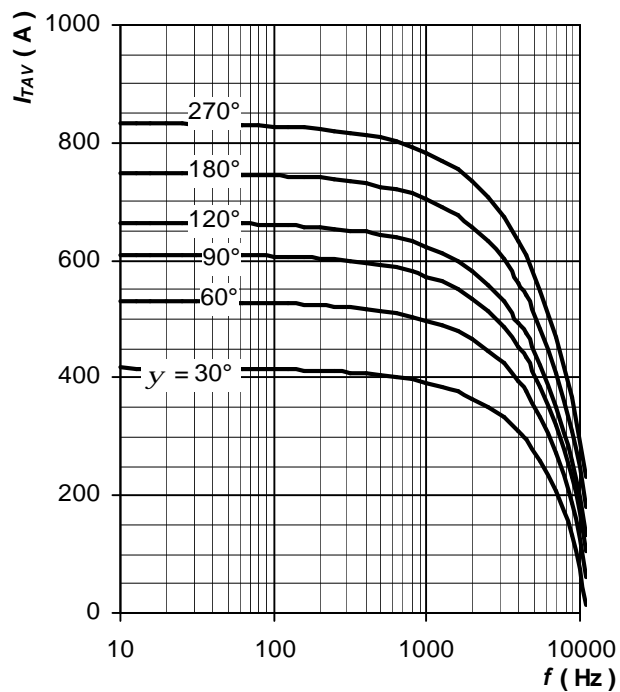

Fig. 21 Average on-state current vs. frequency, trapezoid waveform, $T_C = 70\text{ }^\circ\text{C}$, $di_T/dt = \pm 100\text{ A}/\mu\text{s}$, $V_R = 100\text{ V}$

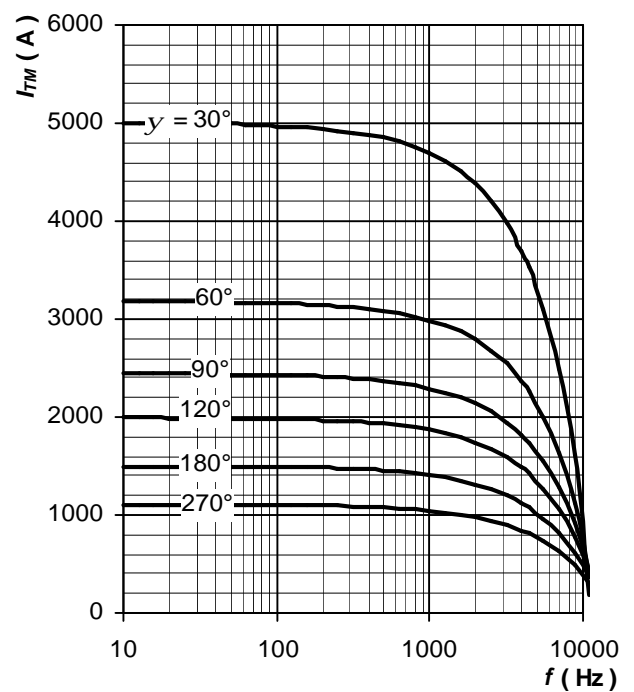

Fig. 22 Maximum on-state current vs. frequency, trapezoid waveform, $T_C = 70\text{ }^\circ\text{C}$, $di_T/dt = \pm 100\text{ A}/\mu\text{s}$, $V_R = 100\text{ V}$

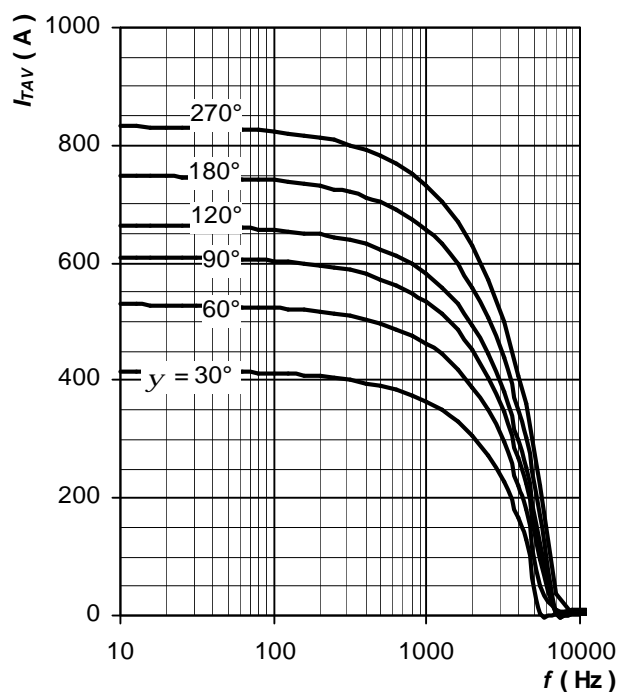

Fig. 23 Average on-state current vs. frequency, trapezoid waveform, $T_C = 70\text{ }^\circ\text{C}$, $di_T/dt = \pm 100\text{ A}/\mu\text{s}$, $V_R = 2/3 V_{DRM}$

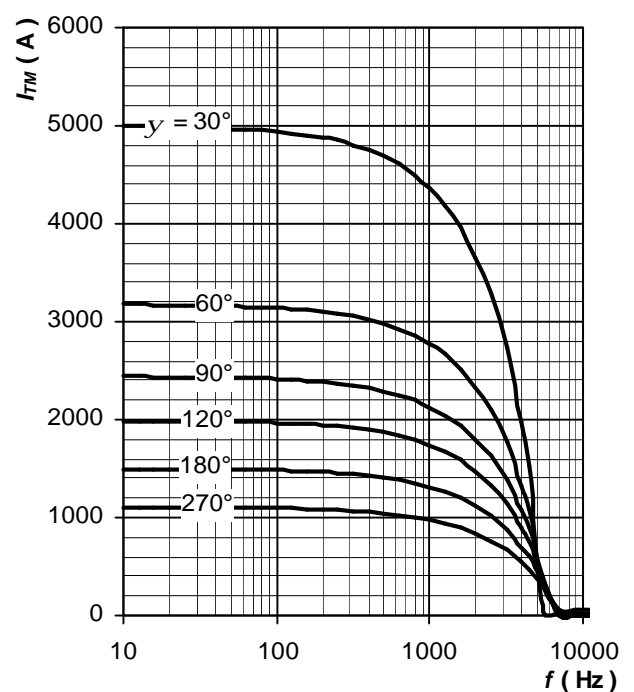

Fig. 24 Maximum on-state current vs. frequency, trapezoid waveform, $T_C = 70\text{ }^\circ\text{C}$, $di_T/dt = \pm 100\text{ A}/\mu\text{s}$, $V_R = 2/3 V_{DRM}$

Frequency Ratings

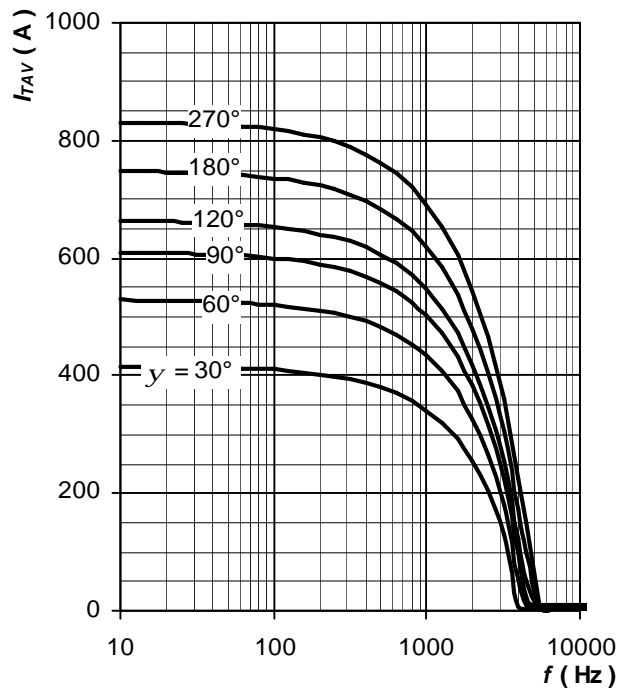

Fig. 25 Average on-state current vs. frequency, trapezoid waveform, $T_C = 70\text{ }^\circ\text{C}$, $di_T/dt = \pm 500\text{ A}/\mu\text{s}$, $V_R = 100\text{ V}$

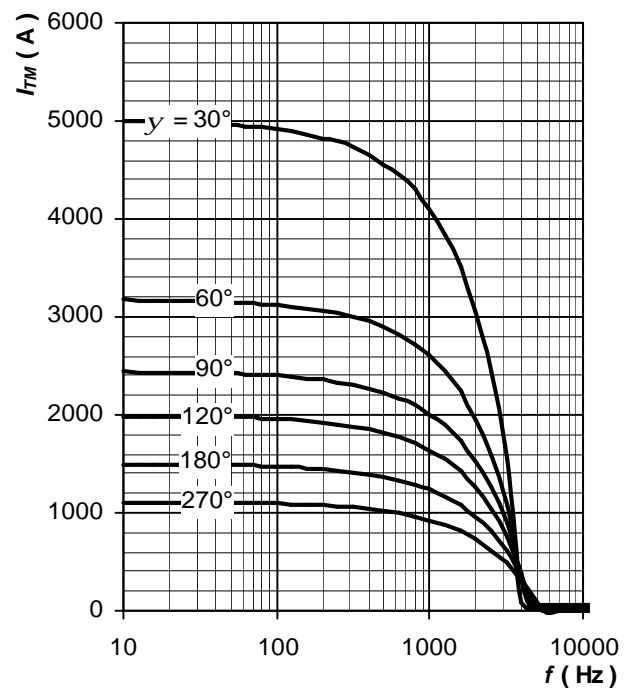

Fig. 26 Maximum on-state current vs. frequency, trapezoid waveform, $T_C = 70\text{ }^\circ\text{C}$, $di_T/dt = \pm 500\text{ A}/\mu\text{s}$, $V_R = 100\text{ V}$

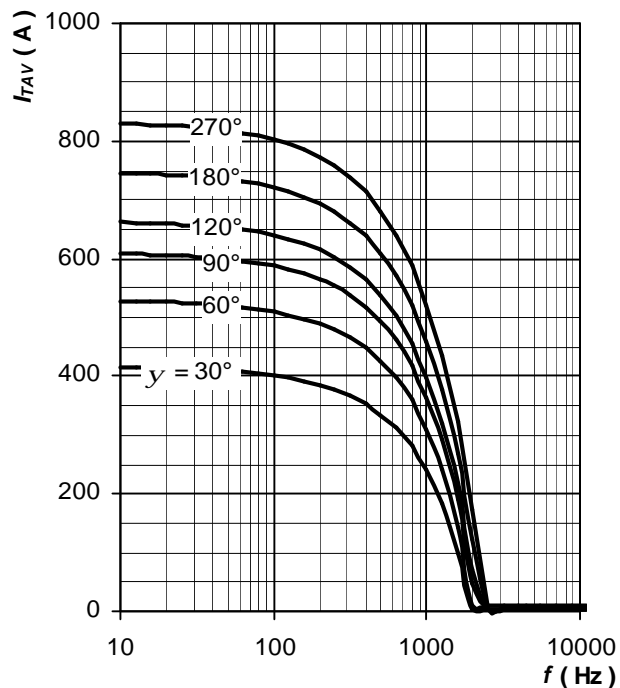

Fig. 27 Average on-state current vs. frequency, trapezoid waveform, $T_C = 70\text{ }^\circ\text{C}$, $di_T/dt = \pm 500\text{ A}/\mu\text{s}$, $V_R = 2/3 V_{DRM}$

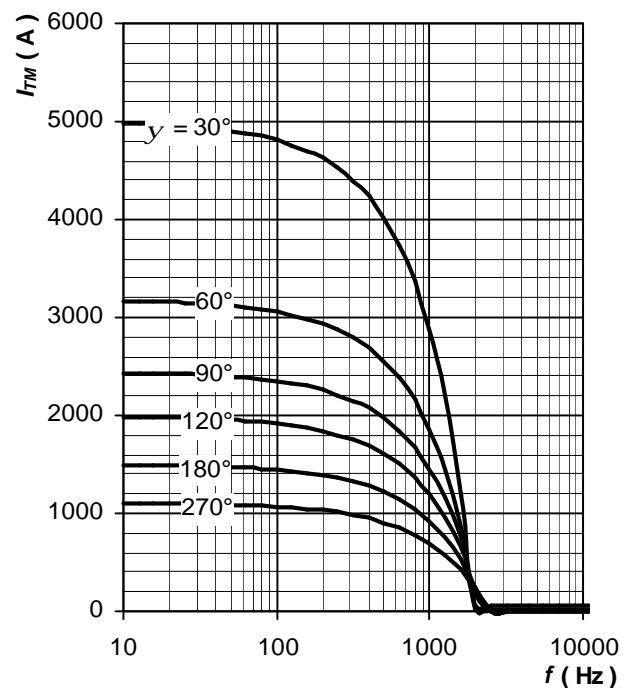

Fig. 28 Maximum on-state current vs. frequency, trapezoid waveform, $T_C = 70\text{ }^\circ\text{C}$, $di_T/dt = \pm 500\text{ A}/\mu\text{s}$, $V_R = 2/3 V_{DRM}$

Frequency Ratings

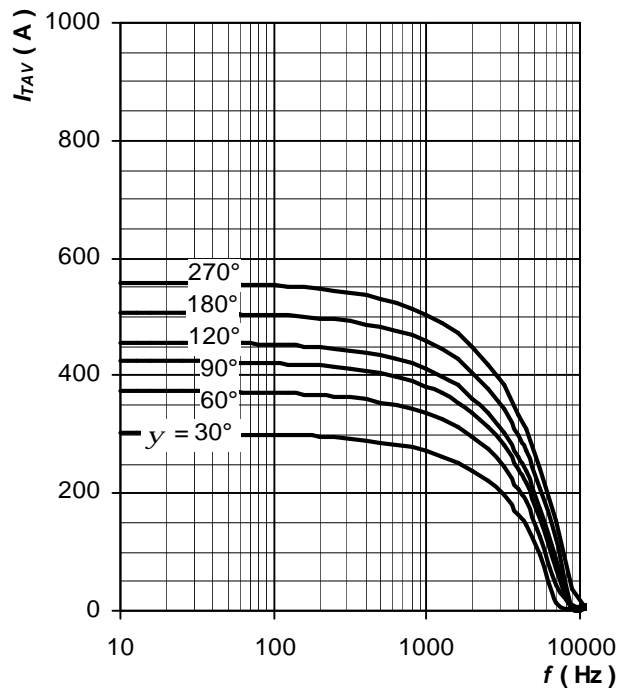

Fig. 29 Average on-state current vs. frequency, trapezoid waveform, $T_C = 90\text{ }^\circ\text{C}$, $di_T/dt = \pm 100\text{ A}/\mu\text{s}$, $V_R = 100\text{ V}$

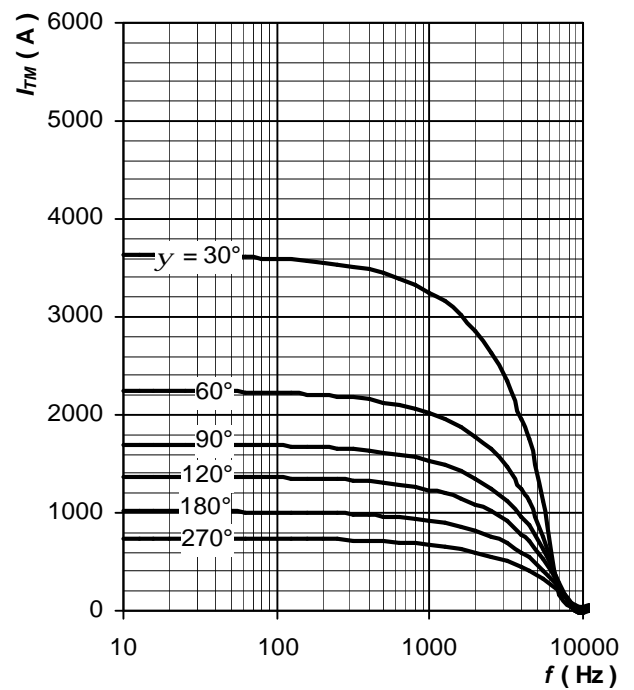

Fig. 30 Maximum on-state current vs. frequency, trapezoid waveform, $T_C = 90\text{ }^\circ\text{C}$, $di_T/dt = \pm 100\text{ A}/\mu\text{s}$, $V_R = 100\text{ V}$

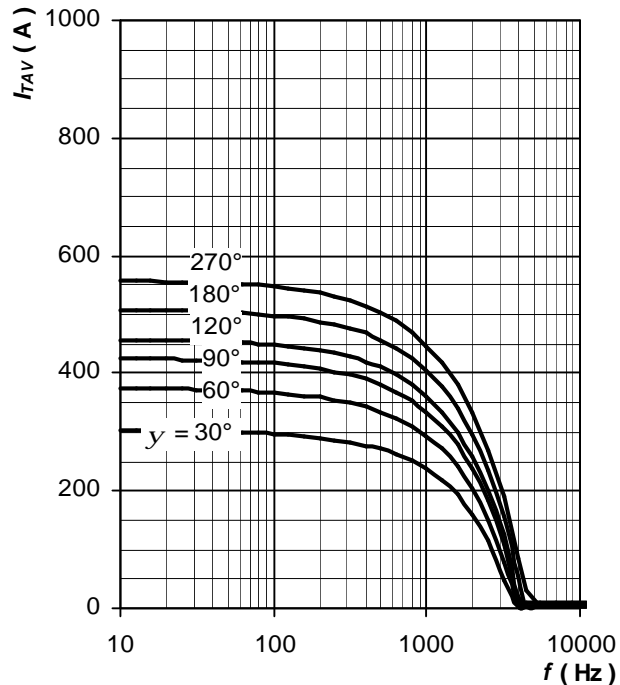

Fig. 31 Average on-state current vs. frequency, trapezoid waveform, $T_C = 90\text{ }^\circ\text{C}$, $di_T/dt = \pm 100\text{ A}/\mu\text{s}$, $V_R = 2/3 V_{DRM}$

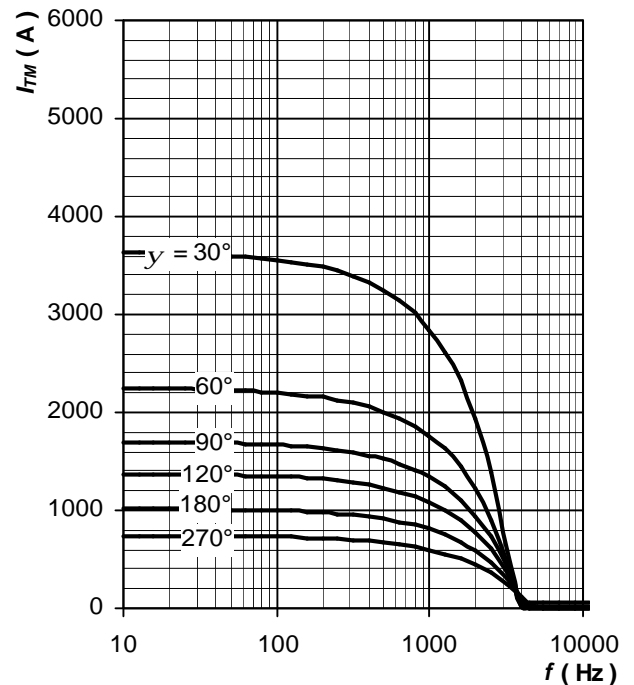

Fig. 32 Maximum on-state current vs. frequency, trapezoid waveform, $T_C = 90\text{ }^\circ\text{C}$, $di_T/dt = \pm 100\text{ A}/\mu\text{s}$, $V_R = 2/3 V_{DRM}$

Frequency Ratings

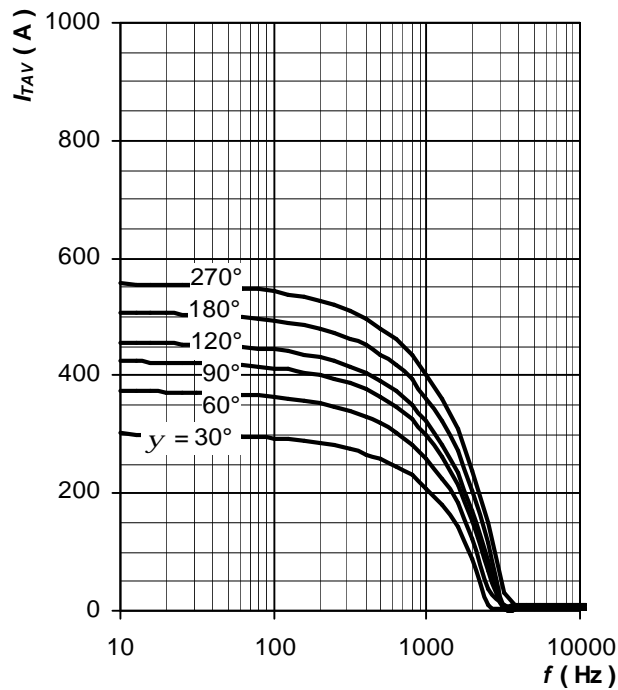

Fig. 33 Average on-state current vs. frequency, trapezoid waveform, $T_C = 90^\circ\text{C}$, $di_T/dt = \pm 500\text{ A}/\mu\text{s}$, $V_R = 100\text{ V}$

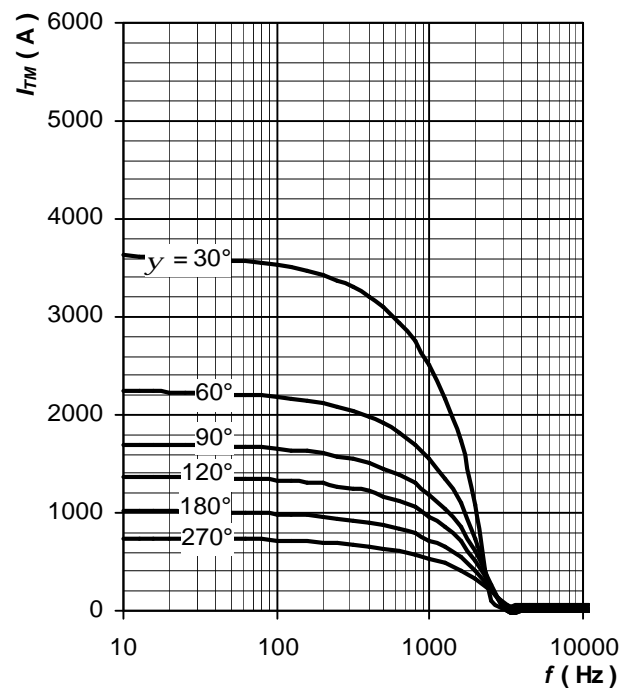

Fig. 34 Maximum on-state current vs. frequency, trapezoid waveform, $T_C = 90^\circ\text{C}$, $di_T/dt = \pm 500\text{ A}/\mu\text{s}$, $V_R = 100\text{ V}$

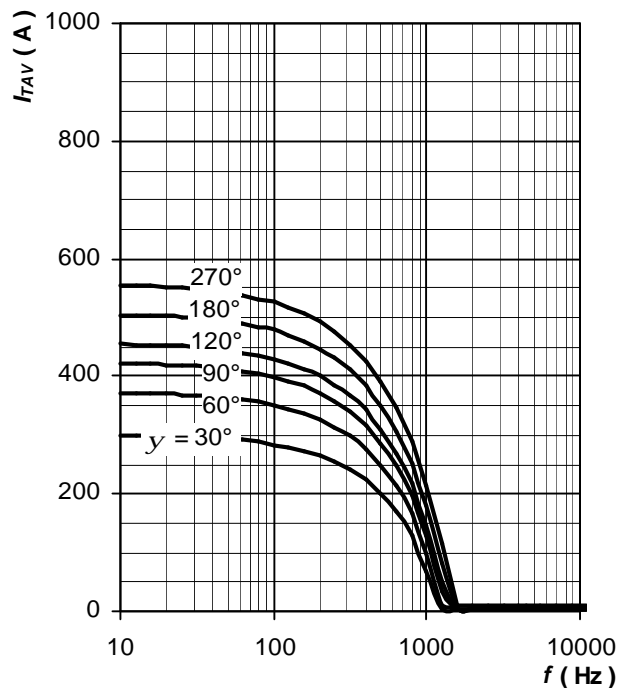

Fig. 35 Average on-state current vs. frequency, trapezoid waveform, $T_C = 90^\circ\text{C}$, $di_T/dt = \pm 500\text{ A}/\mu\text{s}$, $V_R = 2/3 V_{DRM}$

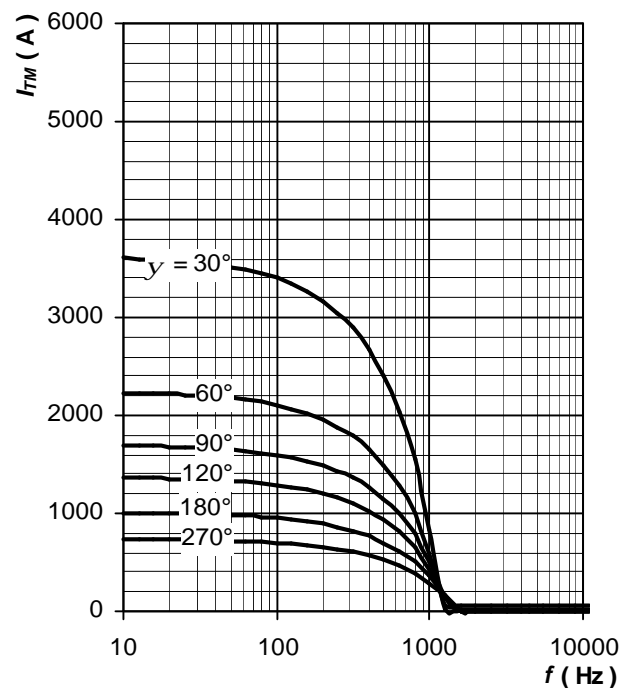

Fig. 36 Maximum on-state current vs. frequency, trapezoid waveform, $T_C = 90^\circ\text{C}$, $di_T/dt = \pm 500\text{ A}/\mu\text{s}$, $V_R = 2/3 V_{DRM}$

Notes:

ABB s.r.o., Novodvorska 1768/138a, 142 21 Praha 4, Czech Republic

ABB s.r.o. reserves the right to change the data contained herein at any time without notice