

5SNA 0500J650300

HiPak IGBT Module

$V_{CE} = 6500 \text{ V}$
 $I_C = 500 \text{ A}$

Ultra low-loss, rugged SPT+ chip-set
 Smooth switching SPT+ chip-set for good EMC
 High insulation package
 AlSiC base-plate for high power cycling capability
 AlN substrate for low thermal resistance
 Improved high reliability package
 Recognized under UL1557, File E196689



Maximum rated values ¹⁾

Parameter	Symbol	Conditions	min	max	Unit
Collector-emitter voltage	V_{CES}	$V_{GE} = 0 \text{ V}$, $T_{vj} \geq 25 \text{ °C}$		6500	V
DC collector current	I_C	$T_C = 85 \text{ °C}$, $T_{vj} = 125 \text{ °C}$		500	A
Peak collector current	I_{CM}	$t_p = 1 \text{ ms}$		1000	A
Gate-emitter voltage	V_{GES}		-20	20	V
Total power dissipation	P_{tot}	$T_C = 25 \text{ °C}$, $T_{vj} = 125 \text{ °C}$		6250	W
DC forward current	I_F			500	A
Peak forward current	I_{FRM}	$t_p = 1 \text{ ms}$		1000	A
Surge current	I_{FSM}	$V_R = 0 \text{ V}$, $T_{vj} = 125 \text{ °C}$, $t_p = 10 \text{ ms}$, half-sinewave		5000	A
IGBT short circuit SOA	t_{psc}	$V_{CC} = 4400 \text{ V}$, $V_{CEM \text{ CHIP}} \leq 6500 \text{ V}$ $V_{GE} \leq 15 \text{ V}$, $T_{vj} \leq 125 \text{ °C}$		10	μs
Isolation voltage	V_{isol}	1 min, $f = 50 \text{ Hz}$		10200	V
Junction temperature	T_{vj}			125	$^{\circ}\text{C}$
Junction operating temperature	$T_{vj(op)}$		-50	125	$^{\circ}\text{C}$
Case temperature	T_C		-50	125	$^{\circ}\text{C}$
Storage temperature	T_{stg}		-50	125	$^{\circ}\text{C}$
Mounting torques ²⁾	M_s	Base-heatsink, M6 screws	4	6	Nm
	M_{t1}	Main terminals, M8 screws	8	10	
	M_{t2}	Auxiliary terminals, M4 screws	2	3	

¹⁾ Maximum rated values indicate limits beyond which damage to the device may occur per IEC 60747

²⁾ For detailed mounting instructions refer to ABB Document No. 5SYA 2039

IGBT characteristic values ³⁾

Parameter	Symbol	Conditions	min	typ	max	Unit
Collector (-emitter) breakdown voltage	$V_{(BR)CES}$	$V_{GE} = 0 \text{ V}$, $I_C = 10 \text{ mA}$, $T_{vj} = 25 \text{ }^\circ\text{C}$	6500			V
Collector-emitter ⁴⁾ saturation voltage	$V_{CE \text{ sat}}$	$I_C = 500 \text{ A}$, $V_{GE} = 15 \text{ V}$	$T_{vj} = 25 \text{ }^\circ\text{C}$	2.9	3.3	V
			$T_{vj} = 125 \text{ }^\circ\text{C}$	3.9	4.5	V
Collector cut-off current	I_{CES}	$V_{CE} = 6500 \text{ V}$, $V_{GE} = 0 \text{ V}$	$T_{vj} = 25 \text{ }^\circ\text{C}$		8	mA
			$T_{vj} = 125 \text{ }^\circ\text{C}$	40	70	mA
Gate leakage current	I_{GES}	$V_{CE} = 0 \text{ V}$, $V_{GE} = \pm 20 \text{ V}$, $T_{vj} = 125 \text{ }^\circ\text{C}$	-500		500	nA
Gate-emitter threshold voltage	$V_{GE(TO)}$	$I_C = 160 \text{ mA}$, $V_{CE} = V_{GE}$, $T_{vj} = 25 \text{ }^\circ\text{C}$	5.5		7.5	V
Gate charge	Q_{ge}	$I_C = 500 \text{ A}$, $V_{CE} = 3600 \text{ V}$, $V_{GE} = -15 \text{ V} \dots 15 \text{ V}$		5.3		μC
Input capacitance	C_{ies}	$V_{CE} = 25 \text{ V}$, $V_{GE} = 0 \text{ V}$, $f = 1 \text{ MHz}$, $T_{vj} = 25 \text{ }^\circ\text{C}$		75.6		nF
Output capacitance	C_{oes}			4.4		nF
Reverse transfer capacitance	C_{res}			1.3		nF
Internal gate resistance	R_{Gint}			1.3		Ω
Turn-on delay time	$t_{d(on)}$	$V_{CC} = 3600 \text{ V}$, $I_C = 500 \text{ A}$, $R_G = 3.9 \text{ } \Omega$, $C_{GE} = 150 \text{ nF}$, $V_{GE} = \pm 15 \text{ V}$, $L_\sigma = 280 \text{ nH}$, inductive load	$T_{vj} = 25 \text{ }^\circ\text{C}$	780		ns
			$T_{vj} = 125 \text{ }^\circ\text{C}$	710		ns
Rise time	t_r	$V_{CC} = 3600 \text{ V}$, $I_C = 500 \text{ A}$, $R_G = 3.9 \text{ } \Omega$, $C_{GE} = 150 \text{ nF}$, $V_{GE} = \pm 15 \text{ V}$, $L_\sigma = 280 \text{ nH}$, inductive load	$T_{vj} = 25 \text{ }^\circ\text{C}$	200		ns
			$T_{vj} = 125 \text{ }^\circ\text{C}$	240		ns
Turn-off delay time	$t_{d(off)}$	$V_{CC} = 3600 \text{ V}$, $I_C = 500 \text{ A}$, $R_G = 22 \text{ } \Omega$, $C_{GE} = 150 \text{ nF}$, $V_{GE} = \pm 15 \text{ V}$, $L_\sigma = 280 \text{ nH}$, inductive load	$T_{vj} = 25 \text{ }^\circ\text{C}$	4750		ns
			$T_{vj} = 125 \text{ }^\circ\text{C}$	5300		ns
Fall time	t_f	$V_{CC} = 3600 \text{ V}$, $I_C = 500 \text{ A}$, $R_G = 22 \text{ } \Omega$, $C_{GE} = 150 \text{ nF}$, $V_{GE} = \pm 15 \text{ V}$, $L_\sigma = 280 \text{ nH}$, inductive load	$T_{vj} = 25 \text{ }^\circ\text{C}$	530		ns
			$T_{vj} = 125 \text{ }^\circ\text{C}$	660		ns
Turn-on switching energy	E_{on}	$V_{CC} = 3600 \text{ V}$, $I_C = 500 \text{ A}$, $R_G = 3.9 \text{ } \Omega$, $C_{GE} = 150 \text{ nF}$, $V_{GE} = \pm 15 \text{ V}$, $L_\sigma = 280 \text{ nH}$, inductive load	$T_{vj} = 25 \text{ }^\circ\text{C}$	2750		mJ
			$T_{vj} = 125 \text{ }^\circ\text{C}$	3950		mJ
Turn-off switching energy	E_{off}	$V_{CC} = 3600 \text{ V}$, $I_C = 500 \text{ A}$, $R_G = 22 \text{ } \Omega$, $C_{GE} = 150 \text{ nF}$, $V_{GE} = \pm 15 \text{ V}$, $L_\sigma = 280 \text{ nH}$, inductive load	$T_{vj} = 25 \text{ }^\circ\text{C}$	2700		mJ
			$T_{vj} = 125 \text{ }^\circ\text{C}$	3500		mJ
Short circuit current	I_{SC}	$t_{psc} \leq 10 \text{ } \mu\text{s}$, $V_{GE} = 15 \text{ V}$, $V_{CC} = 4400 \text{ V}$, $V_{CEM \text{ CHIP}} \leq 6500 \text{ V}$	$T_{vj} = 125 \text{ }^\circ\text{C}$	2250		A

³⁾ Characteristic values according to IEC 60747 - 9

⁴⁾ Collector-emitter saturation voltage is given at chip level

Diode characteristic values ⁵⁾

Parameter	Symbol	Conditions	min	typ	max	Unit
Forward voltage ⁶⁾	V_F	$I_F = 500 \text{ A}$	$T_{vj} = 25 \text{ }^\circ\text{C}$	3.2	3.8	V
			$T_{vj} = 125 \text{ }^\circ\text{C}$	3.4	4.0	V
Reverse recovery current	I_{rr}		$T_{vj} = 25 \text{ }^\circ\text{C}$	610		A
			$T_{vj} = 125 \text{ }^\circ\text{C}$	650		A
Recovered charge	Q_{rr}	$V_{CC} = 3600 \text{ V}$, $I_F = 500 \text{ A}$, $V_{GE} = \pm 15 \text{ V}$, $R_G = 3.9 \text{ } \Omega$, $C_{GE} = 150 \text{ nF}$, $dI/dt = 2 \text{ kA}/\mu\text{s}$ $L_\sigma = 280 \text{ nH}$, inductive load	$T_{vj} = 25 \text{ }^\circ\text{C}$	550		μC
			$T_{vj} = 125 \text{ }^\circ\text{C}$	950		μC
Reverse recovery time	t_{rr}		$T_{vj} = 25 \text{ }^\circ\text{C}$	1800		ns
			$T_{vj} = 125 \text{ }^\circ\text{C}$	2800		ns
Reverse recovery energy	E_{rec}		$T_{vj} = 25 \text{ }^\circ\text{C}$	900		mJ
			$T_{vj} = 125 \text{ }^\circ\text{C}$	1850		mJ

⁵⁾ Characteristic values according to IEC 60747 - 2

⁶⁾ Forward voltage is given at chip level

Package properties ⁷⁾

Parameter	Symbol	Conditions	min	typ	max	Unit
IGBT thermal resistance junction to case	$R_{th(j-c)IGBT}$				0.016	K/W
Diode thermal resistance junction to case	$R_{th(j-c)DIODE}$				0.032	K/W
IGBT thermal resistance ²⁾ case to heatsink	$R_{th(c-s)IGBT}$	IGBT per switch, λ grease = $1\text{W}/\text{m} \times \text{K}$		0.012		K/W
Diode thermal resistance ²⁾ case to heatsink	$R_{th(c-s)DIODE}$	Diode per switch, λ grease = $1\text{W}/\text{m} \times \text{K}$		0.024		K/W
Partial discharge extinction voltage	V_e	$f = 50 \text{ Hz}$, $Q_{PD} \leq 10 \text{ pC}$ (acc. To IEC 61287)	5100			V
Comparative tracking index	CTI			> 600		
Module stray inductance	$L_{\sigma CE}$			27		nH
Resistance, terminal-chip	$R_{CC'+EE'}$		$T_C = 25 \text{ }^\circ\text{C}$	0.1		$\text{m}\Omega$
			$T_C = 125 \text{ }^\circ\text{C}$	0.15		

²⁾ For detailed mounting instructions refer to ABB Document No. 5SYA 2039

Mechanical properties ⁷⁾

Parameter	Symbol	Conditions	min	typ	max	Unit
Dimensions	L x W x H	Typical		130 x 140 x 48		mm
Clearance distance in air	d_a	according to IEC 60664-1 and EN 50124-1	Term. to base:	40		mm
			Term. to term:	26		
Surface creepage distance	d_s	according to IEC 60664-1 and EN 50124-1	Term. to base:	64		mm
			Term. to term:	56		
Mass	m			1010		g

⁷⁾ Package and mechanical properties according to IEC 60747 - 15

Electrical configuration

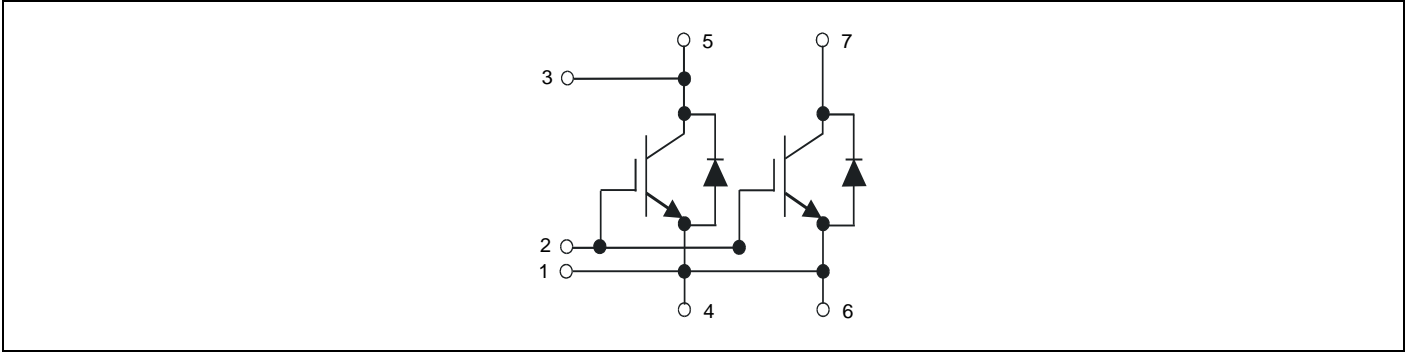

Outline drawing ²⁾

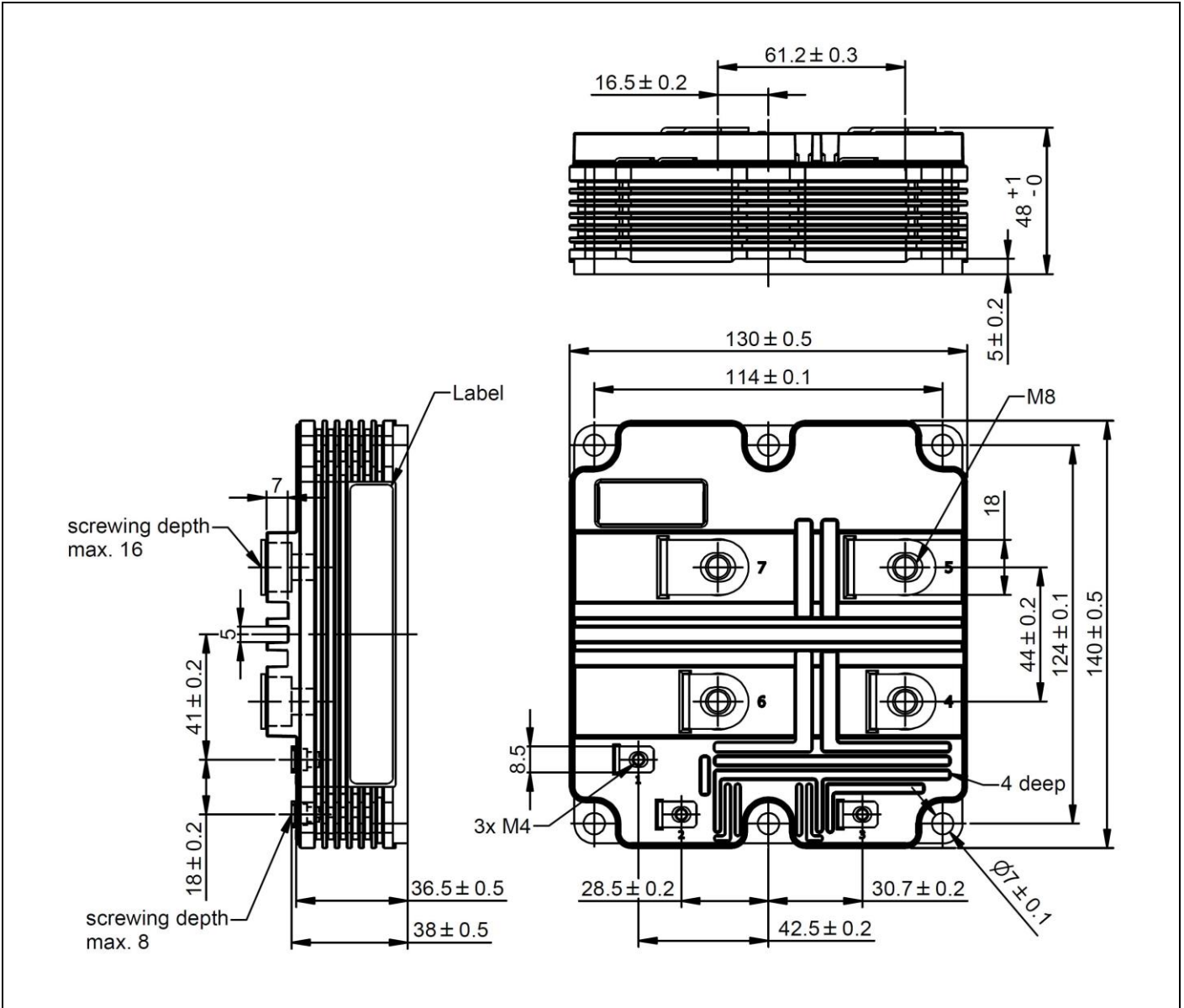

Note: all dimensions are shown in millimeters

²⁾ For detailed mounting instructions refer to ABB Document No. 5SYA 2039

This is an electrostatic sensitive device, please observe the international standard IEC 60747-1, chap. IX. This product has been designed and qualified for Industrial Level.

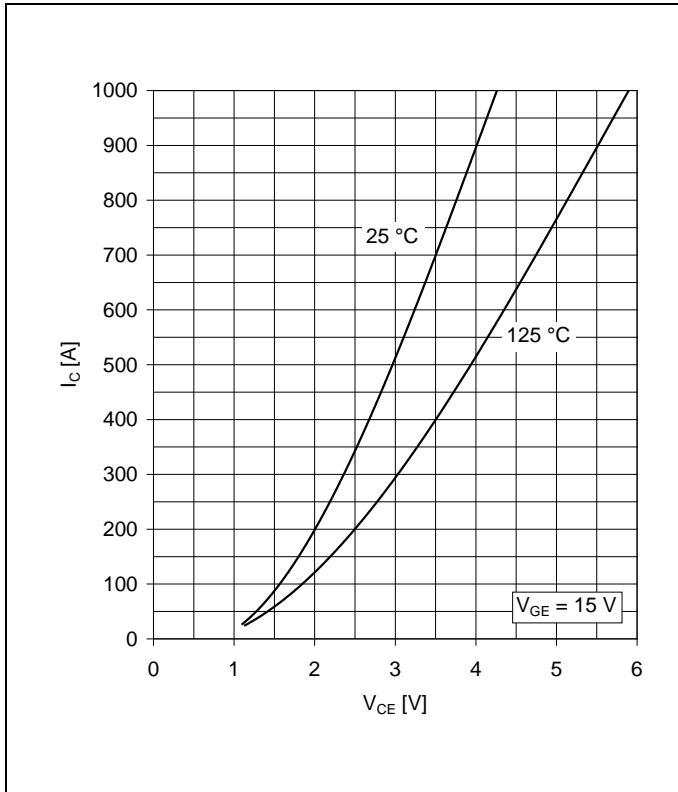

Fig. 1 Typical on-state characteristics, chip level

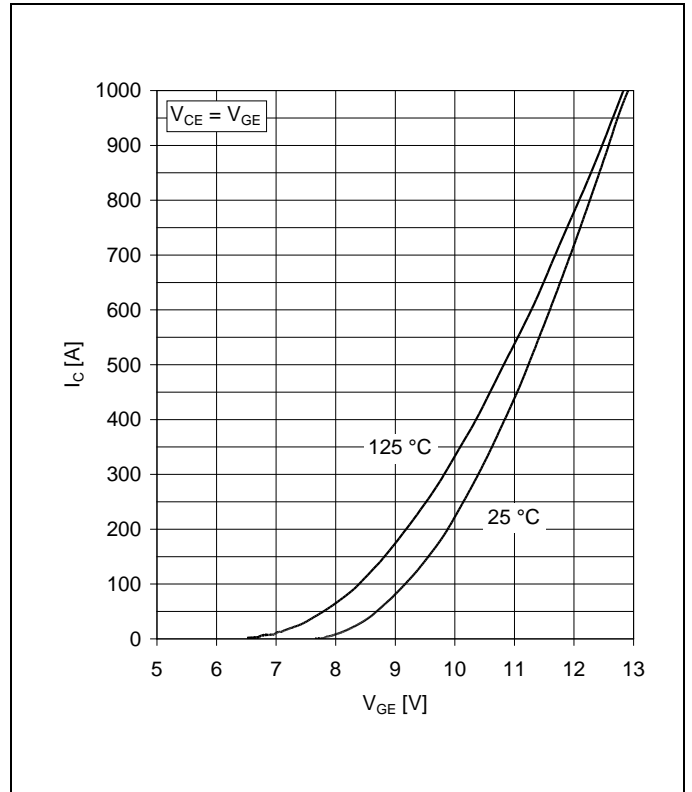

Fig. 2 Typical transfer characteristics, chip level

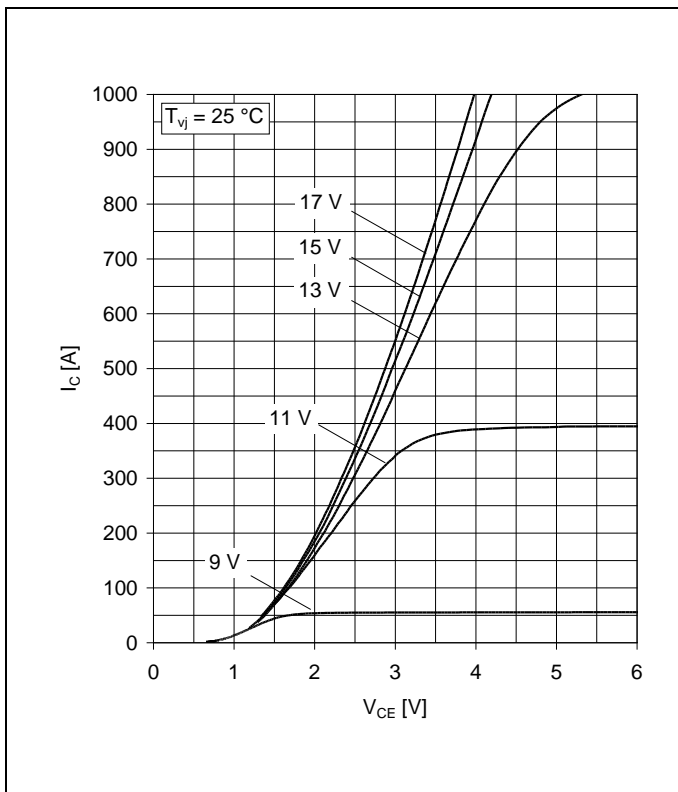

Fig. 3 Typical output characteristics, chip level

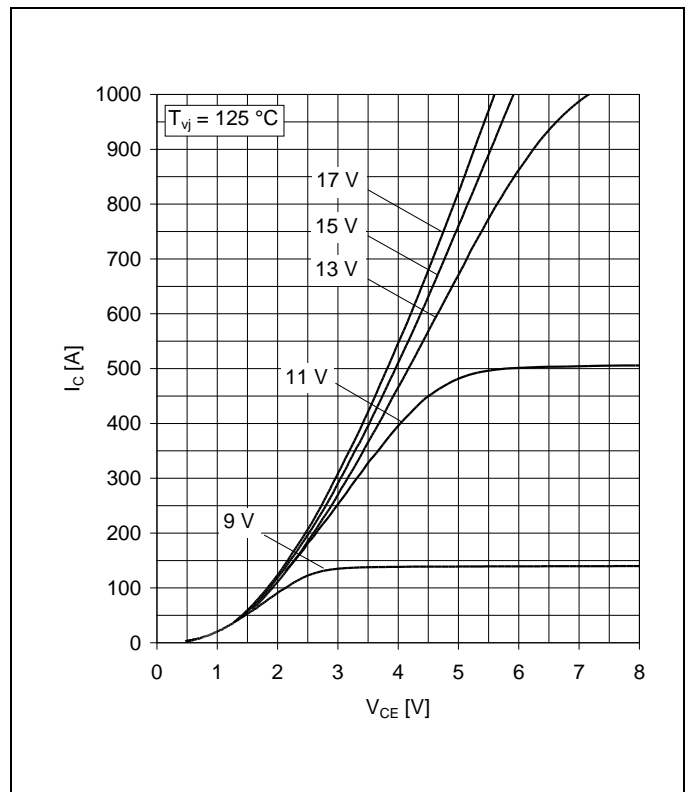

Fig. 4 Typical output characteristics, chip level

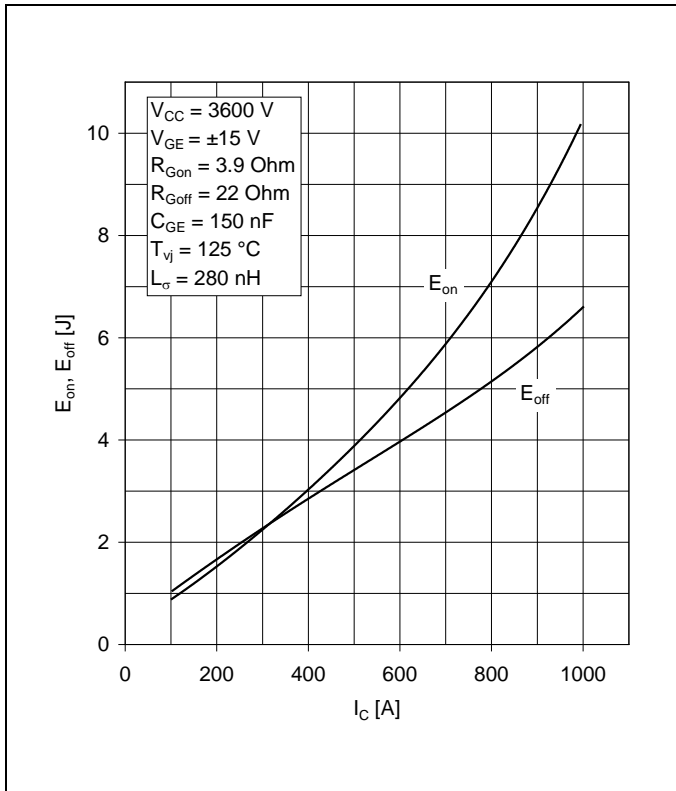

Fig. 5 Typical switching energies per pulse vs. collector current

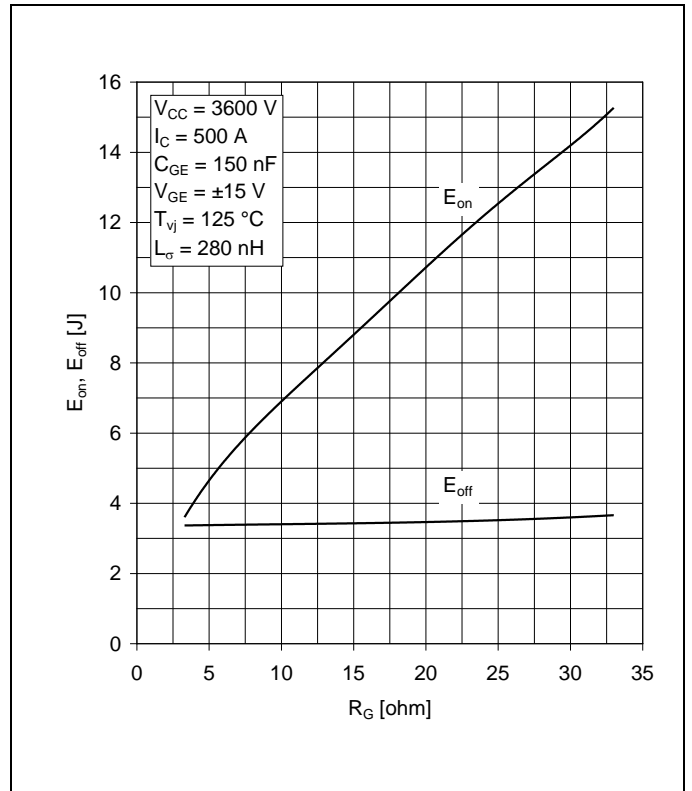

Fig. 6 Typical switching energies per pulse vs. gate resistor

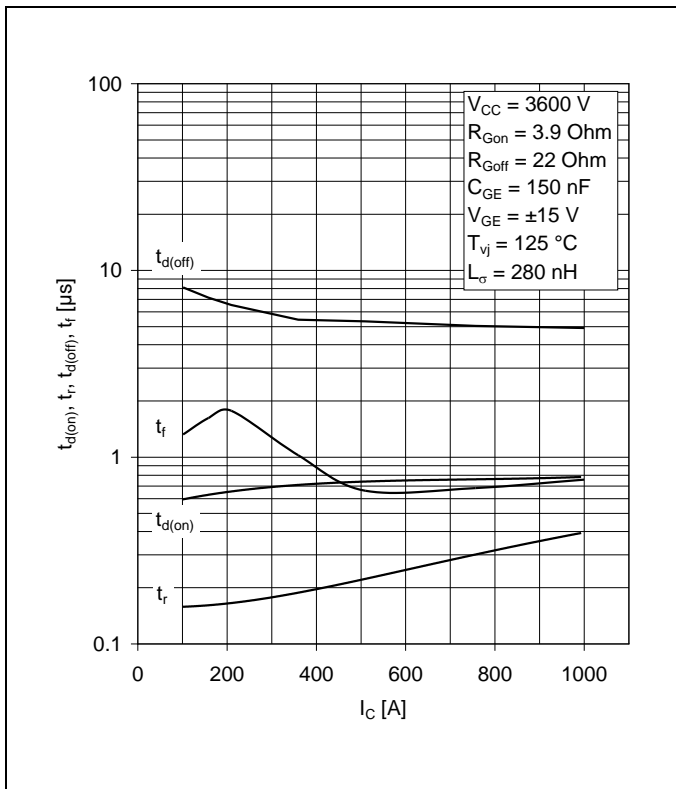

Fig. 7 Typical switching times vs. collector current

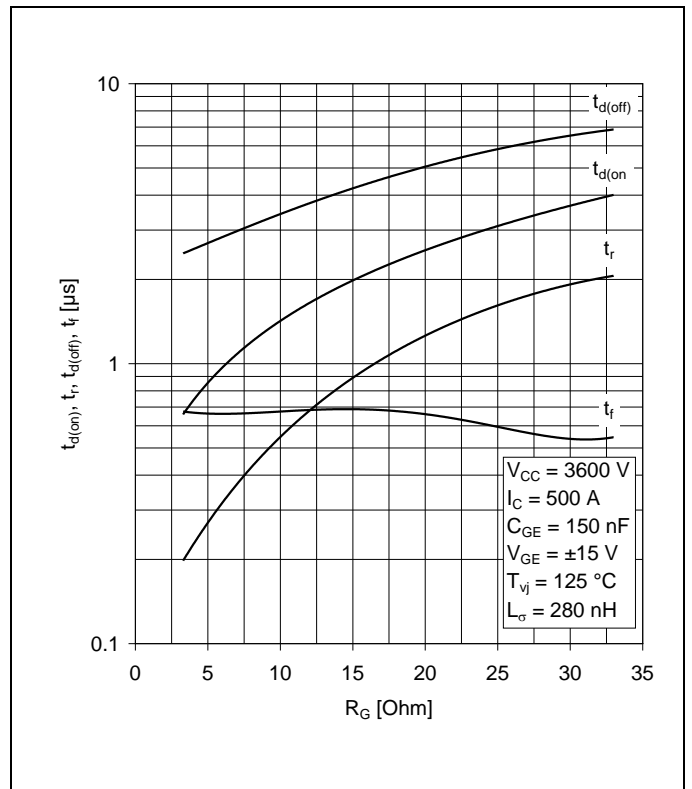

Fig. 8 Typical switching times vs. gate resistor

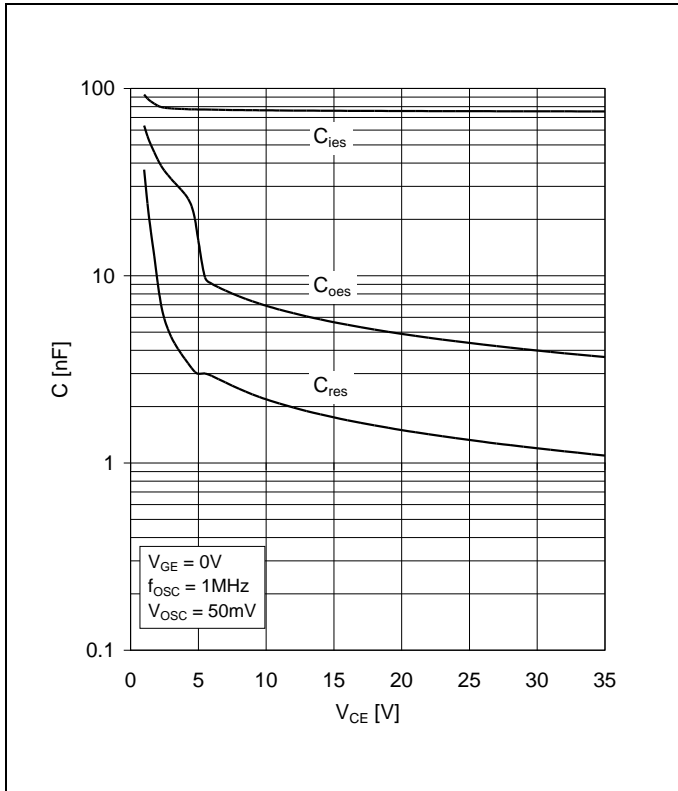

Fig. 9 Typical capacitances vs. collector-emitter voltage

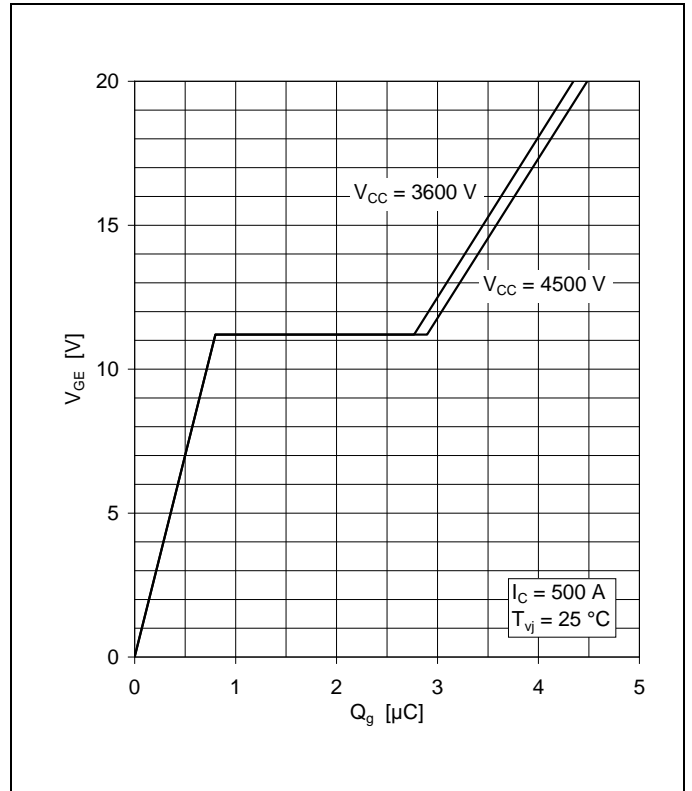

Fig. 10 Typical gate charge characteristics

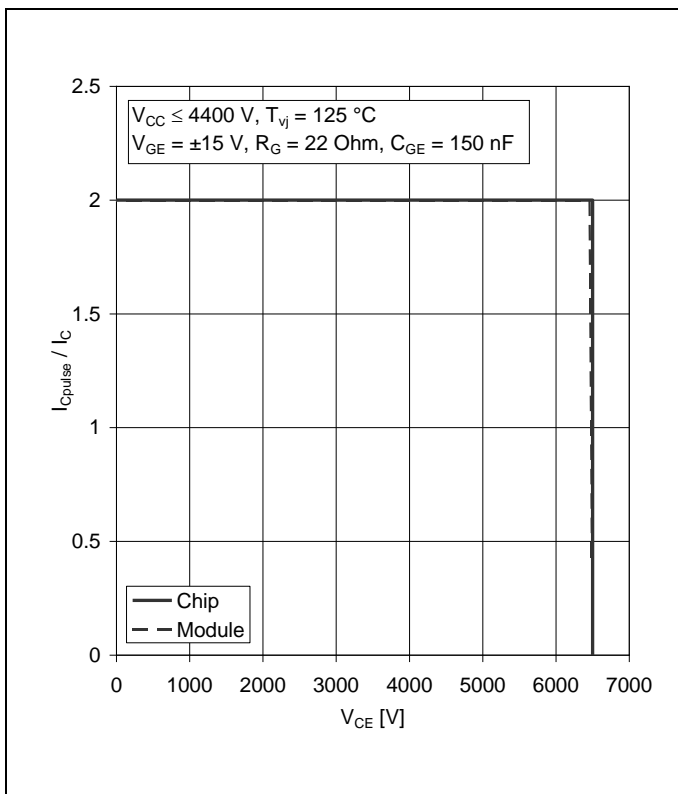

Fig. 11 Turn-off safe operating area (RBSOA)

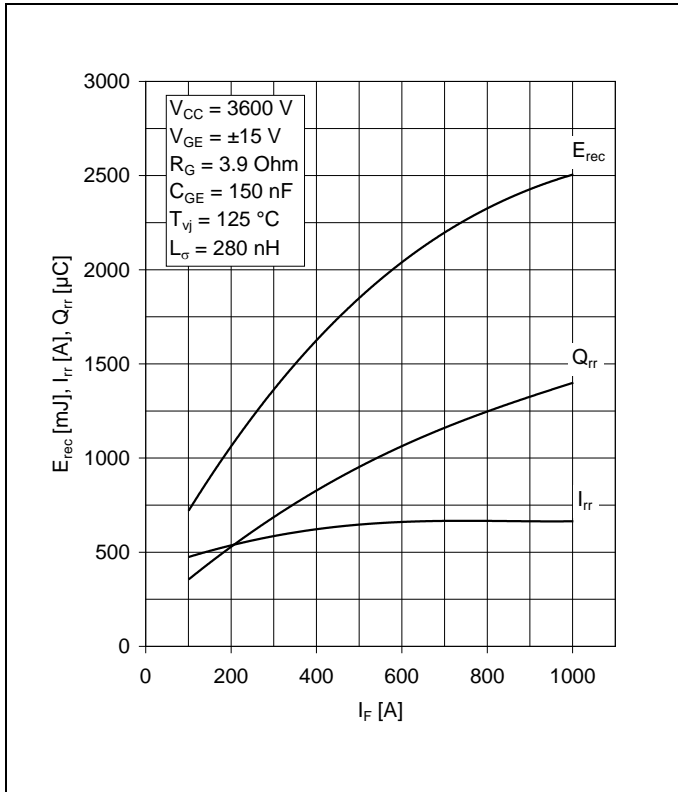

Fig. 12 Typical reverse recovery characteristics vs. forward current

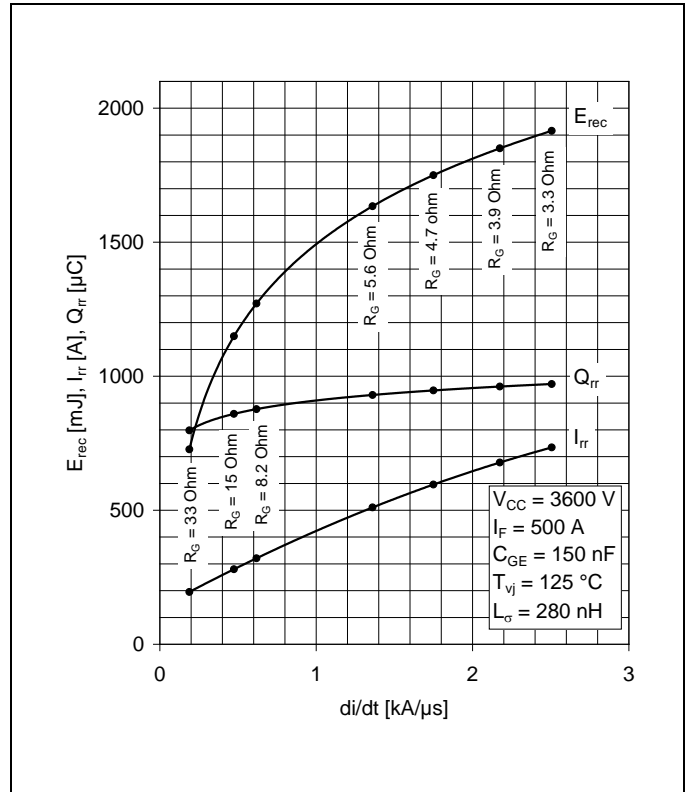

Fig. 13 Typical reverse recovery characteristics vs. di/dt

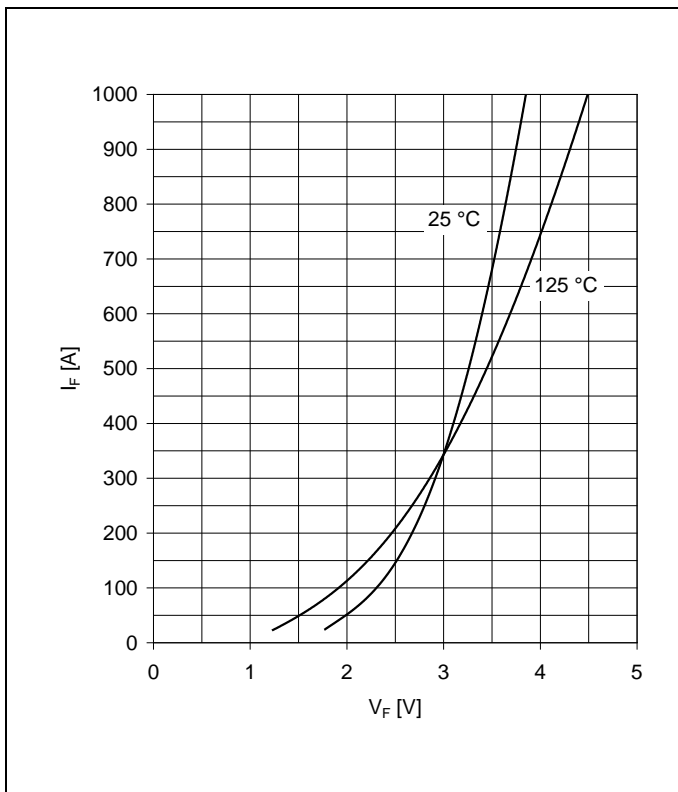

Fig. 14 Typical diode forward characteristics chip level

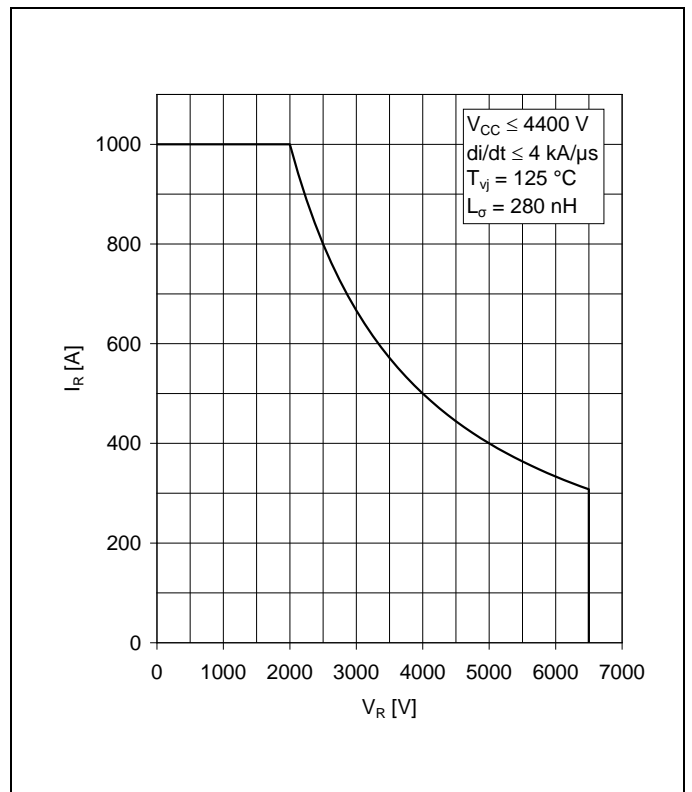

Fig. 15 Safe operating area diode (SOA)

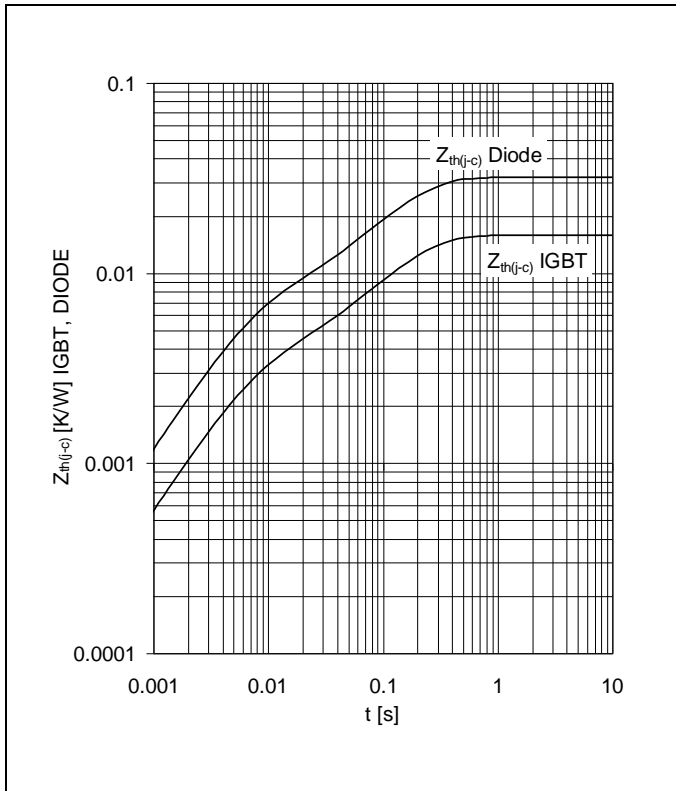

Fig. 16 Thermal impedance vs. time

Analytical function for transient thermal impedance:

$$Z_{th(j-c)}(t) = \sum_{i=1}^n R_i (1 - e^{-t/\tau_i})$$

	i	1	2	3	4	5
IGBT	Ri(K/kW)	12.75	2.99			
	τ_i (ms)	151	5.84			
DIODE	Ri(K/kW)	25.5	6.3			
	τ_i (ms)	144	5.83			

Related documents:

- 5SYA 2042 Failure rates of HiPak modules due to cosmic rays
- 5SYA 2043 Load - cycle capability of HiPaks
- 5SYA 2045 Thermal runaway during blocking
- 5SYA 2053 Applying IGBT
- 5SYA 2058 Surge currents for IGBT diodes
- 5SZK 9111 Specification of environmental class for HiPak Storage
- 5SZK 9112 Specification of environmental class for HiPak Transportation
- 5SZK 9113 Specification of environmental class for HiPak Operation (Industry)
- 5SZK 9120 Specification of environmental class for HiPak

ABB Switzerland Ltd.
Semiconductors
Fabrikstrasse 3
CH-5600 Lenzburg
Switzerland

Phone: +41 58 586 1419
Fax: +41 58 586 1306
E-Mail: abbsem@ch.abb.com
Internet: www.abb.com/semiconductors

We reserve the right to make technical changes or to modify the contents of this document without prior notice.

We reserve all rights in this document and the information contained therein. Any reproduction or utilization of this document or parts thereof for commercial purposes without our prior written consent is forbidden.

Any liability for use of our products contrary to the instructions in this document is excluded.