

$V_{CE} = 6500 \text{ V}$

$I_C = 400 \text{ A}$

# ABB HiPak

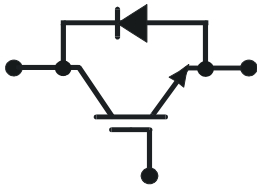

## IGBT Module 5SNA 0400J650100

Doc. No. 5SYA 1592-04 05-2016

- Low-loss, rugged SPT chip-set
- Smooth switching SPT chip-set for good EMC
- High insulation package
- AlSiC base-plate for high power cycling capability
- AlN substrate for low thermal resistance
- Improved high reliability package
- Recognized under UL1557, File E196689



### Maximum rated values <sup>1)</sup>

Parameter	Symbol	Conditions	min	max	Unit
Collector-emitter voltage	$V_{CES}$	$V_{GE} = 0 \text{ V}, T_{vj} \geq 25 \text{ °C}$		6500	V
DC collector current	$I_C$	$T_c = 85 \text{ °C}$		400	A
Peak collector current	$I_{CM}$	$t_p = 1 \text{ ms}, T_c = 85 \text{ °C}$		800	A
Gate-emitter voltage	$V_{GES}$		-20	20	V
Total power dissipation	$P_{tot}$	$T_c = 25 \text{ °C}$ , per switch (IGBT)		7350	W
DC forward current	$I_F$			400	A
Peak forward current	$I_{FRM}$			800	A
Surge current	$I_{FSM}$	$V_R = 0 \text{ V}, T_{vj} = 125 \text{ °C}$ , $t_p = 10 \text{ ms}$ , half-sinewave		4000	A
IGBT short circuit SOA	$t_{psc}$	$V_{CC} = 4400 \text{ V}, V_{CEMCHIP} \leq 6500 \text{ V}$ $V_{GE} \leq 15 \text{ V}, T_{vj} \leq 125 \text{ °C}$		10	$\mu\text{s}$
Isolation voltage	$V_{isol}$	1 min, $f = 50 \text{ Hz}$		10200	V
Junction temperature	$T_{vj}$			125	$^{\circ}\text{C}$
Junction operating temperature	$T_{vj(op)}$		-50	125	$^{\circ}\text{C}$
Case temperature	$T_c$		-50	125	$^{\circ}\text{C}$
Storage temperature	$T_{stg}$		-50	125	$^{\circ}\text{C}$
Mounting torques <sup>2)</sup>	$M_s$	Base-heatsink, M6 screws	4	6	Nm
	$M_{t1}$	Main terminals, M8 screws	8	10	
	$M_{t2}$	Auxiliary terminals, M4 screws	2	3	

<sup>1)</sup> Maximum rated values indicate limits beyond which damage to the device may occur per IEC 60747

<sup>2)</sup> For detailed mounting instructions refer to ABB Document No. 5SYA2039

ABB Switzerland Ltd, Semiconductors reserves the right to change specifications without notice.



IGBT characteristic values <sup>3)</sup>

Parameter	Symbol	Conditions	min	typ	max	Unit
Collector (-emitter) breakdown voltage	$V_{(BR)CES}$	$V_{GE} = 0 \text{ V}$ , $I_C = 10 \text{ mA}$ , $T_{vj} = 25 \text{ °C}$	6500			V
Collector-emitter <sup>4)</sup> saturation voltage	$V_{CE \text{ sat}}$	$I_C = 400 \text{ A}$ , $V_{GE} = 15 \text{ V}$	$T_{vj} = 25 \text{ °C}$	4.2	4.8	V
			$T_{vj} = 125 \text{ °C}$	5.4	5.9	V
Collector cut-off current	$I_{CES}$	$V_{CE} = 6500 \text{ V}$ , $V_{GE} = 0 \text{ V}$	$T_{vj} = 25 \text{ °C}$		8	mA
			$T_{vj} = 125 \text{ °C}$	35	80	mA
Gate leakage current	$I_{GES}$	$V_{CE} = 0 \text{ V}$ , $V_{GE} = \pm 20 \text{ V}$ , $T_{vj} = 125 \text{ °C}$	-500		500	nA
Gate-emitter threshold voltage	$V_{GE(TO)}$	$I_C = 160 \text{ mA}$ , $V_{CE} = V_{GE}$ , $T_{vj} = 25 \text{ °C}$	6	7.4	8	V
Gate charge	$Q_{ge}$	$I_C = 400 \text{ A}$ , $V_{CE} = 3600 \text{ V}$ , $V_{GE} = -15 \text{ V} \dots 15 \text{ V}$		5.3		$\mu\text{C}$
Input capacitance	$C_{ies}$	$V_{CE} = 25 \text{ V}$ , $V_{GE} = 0 \text{ V}$ , $f = 1 \text{ MHz}$ , $T_{vj} = 25 \text{ °C}$		95.3		nF
Output capacitance	$C_{oes}$			4.41		
Reverse transfer capacitance	$C_{res}$			0.85		
Internal gate resistance	$R_{Gint}$			0.81		$\Omega$
Turn-on delay time	$t_{d(on)}$	$V_{CC} = 3600 \text{ V}$ , $I_C = 400 \text{ A}$ , $R_G = 5.6 \text{ }\Omega$ ,	$T_{vj} = 25 \text{ °C}$	700		ns
			$T_{vj} = 125 \text{ °C}$	630		
Rise time	$t_r$	$V_{GE} = \pm 15 \text{ V}$ , $L_\sigma = 280 \text{ nH}$ , inductive load	$T_{vj} = 25 \text{ °C}$	250		ns
			$T_{vj} = 125 \text{ °C}$	220		
Turn-off delay time	$t_{d(off)}$	$V_{CC} = 3600 \text{ V}$ , $I_C = 400 \text{ A}$ , $R_G = 5.6 \text{ }\Omega$ ,	$T_{vj} = 25 \text{ °C}$	1410		ns
			$T_{vj} = 125 \text{ °C}$	1700		
Fall time	$t_f$	$V_{GE} = \pm 15 \text{ V}$ , $L_\sigma = 280 \text{ nH}$ , inductive load	$T_{vj} = 25 \text{ °C}$	650		ns
			$T_{vj} = 125 \text{ °C}$	980		
Turn-on switching energy	$E_{on}$	$V_{CC} = 3600 \text{ V}$ , $I_C = 400 \text{ A}$ , $V_{GE} = \pm 15 \text{ V}$ , $R_G = 5.6 \text{ }\Omega$ , $L_\sigma = 280 \text{ nH}$ , inductive load	$T_{vj} = 25 \text{ °C}$	2250		mJ
			$T_{vj} = 125 \text{ °C}$	2800		
Turn-off switching energy	$E_{off}$	$V_{CC} = 3600 \text{ V}$ , $I_C = 400 \text{ A}$ , $V_{GE} = \pm 15 \text{ V}$ , $R_G = 5.6 \text{ }\Omega$ , $L_\sigma = 280 \text{ nH}$ , inductive load	$T_{vj} = 25 \text{ °C}$	1340		mJ
			$T_{vj} = 125 \text{ °C}$	2120		
Short circuit current	$I_{SC}$	$t_{psc} \leq 10 \text{ }\mu\text{s}$ , $V_{GE} = 15 \text{ V}$ , $T_{vj} = 125 \text{ °C}$ , $V_{CC} = 4400 \text{ V}$ , $V_{CEM \text{ CHIP}} \leq 6500 \text{ V}$		1800		A
Module stray inductance	$L_{\sigma \text{ CE}}$			20		nH
Resistance, terminal-chip	$R_{CC+EE'}$		$T_C = 25 \text{ °C}$	0.1		m $\Omega$
			$T_C = 125 \text{ °C}$	0.15		

<sup>3)</sup> Characteristic values according to IEC 60747 – 9<sup>4)</sup> Collector-emitter saturation voltage is given at chip level

**Diode characteristic values** <sup>5)</sup>

Parameter	Symbol	Conditions	min	typ	max	Unit
Forward voltage <sup>6)</sup>	$V_F$	$I_F = 400 \text{ A}$	$T_{vj} = 25 \text{ °C}$	3.2	3.8	V
			$T_{vj} = 125 \text{ °C}$	3.4	4.0	
Reverse recovery current	$I_{rr}$		$T_{vj} = 25 \text{ °C}$	510		A
			$T_{vj} = 125 \text{ °C}$	680		
Recovered charge	$Q_{rr}$	$V_{CC} = 3600 \text{ V}$ , $I_F = 400 \text{ A}$ , $V_{GE} = \pm 15 \text{ V}$ , $R_G = 5.6 \text{ } \Omega$ $L_\sigma = 280 \text{ nH}$ inductive load	$T_{vj} = 25 \text{ °C}$	450		$\mu\text{C}$
			$T_{vj} = 125 \text{ °C}$	770		
Reverse recovery time	$t_{rr}$		$T_{vj} = 25 \text{ °C}$	1840		ns
			$T_{vj} = 125 \text{ °C}$	2120		
Reverse recovery energy	$E_{rec}$		$T_{vj} = 25 \text{ °C}$	670		mJ
			$T_{vj} = 125 \text{ °C}$	1380		

<sup>5)</sup> Characteristic values according to IEC 60747 – 2

<sup>6)</sup> Forward voltage is given at chip level

**Package properties** <sup>7)</sup>

Parameter	Symbol	Conditions	min	typ	max	Unit
IGBT thermal resistance junction to case	$R_{th(j-c)IGBT}$				0.016	K/W
Diode thermal resistance junction to case	$R_{th(j-c)DIODE}$				0.032	K/W
IGBT thermal resistance <sup>2)</sup> case to heatsink	$R_{th(c-s)IGBT}$	IGBT per switch, $\lambda$ grease = $1\text{W/m} \times \text{K}$		0.012		K/W
Diode thermal resistance <sup>7)</sup> case to heatsink	$R_{th(c-s)DIODE}$	Diode per switch, $\lambda$ grease = $1\text{W/m} \times \text{K}$		0.024		K/W
Partial discharge extinction voltage	$V_e$	$f = 50 \text{ Hz}$ , $Q_{PD} \leq 10\text{pC}$ (acc. to IEC 61287)	5100			V
Comparative tracking index	CTI			$\geq 600$		

<sup>2)</sup> For detailed mounting instructions refer to ABB Document No. 5SYA2039

**Mechanical properties** <sup>7)</sup>

Parameter	Symbol	Conditions	min	typ	max	Unit
Dimensions	$L \times W \times H$	Typical , see outline drawing	130 x 140 x 48			mm
Clearance distance in air	$d_a$	according to IEC 60664-1 and EN 50124-1	Term. to base:	40		mm
			Term. to term:	26		
Surface creepage distance	$d_s$	according to IEC 60664-1 and EN 50124-1	Term. to base:	64		mm
			Term. to term:	56		
Mass	$m$			1010		g

<sup>7)</sup> Package and mechanical properties according to IEC 60747 – 15

### Electrical configuration

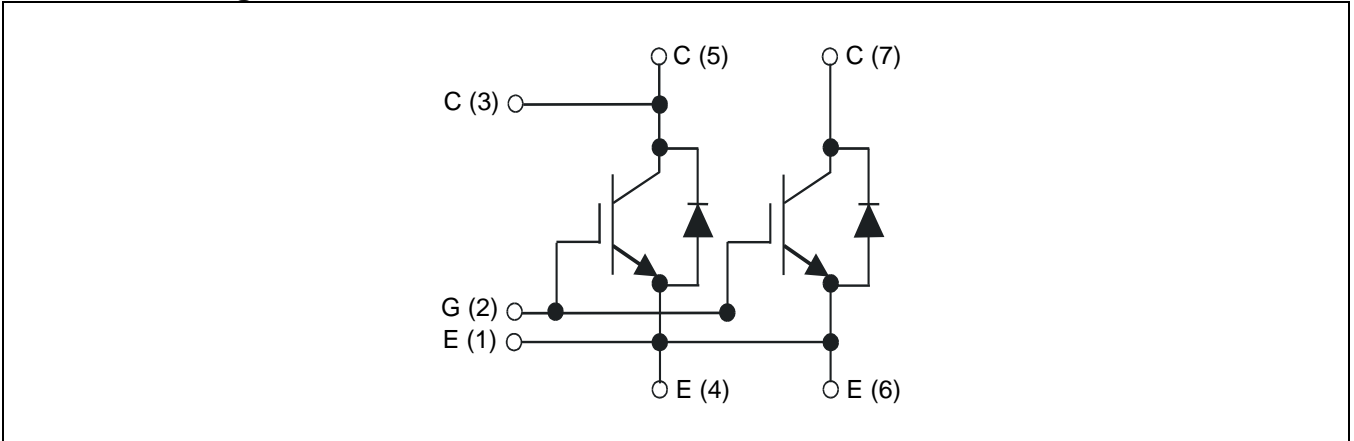

### Outline drawing <sup>2)</sup>

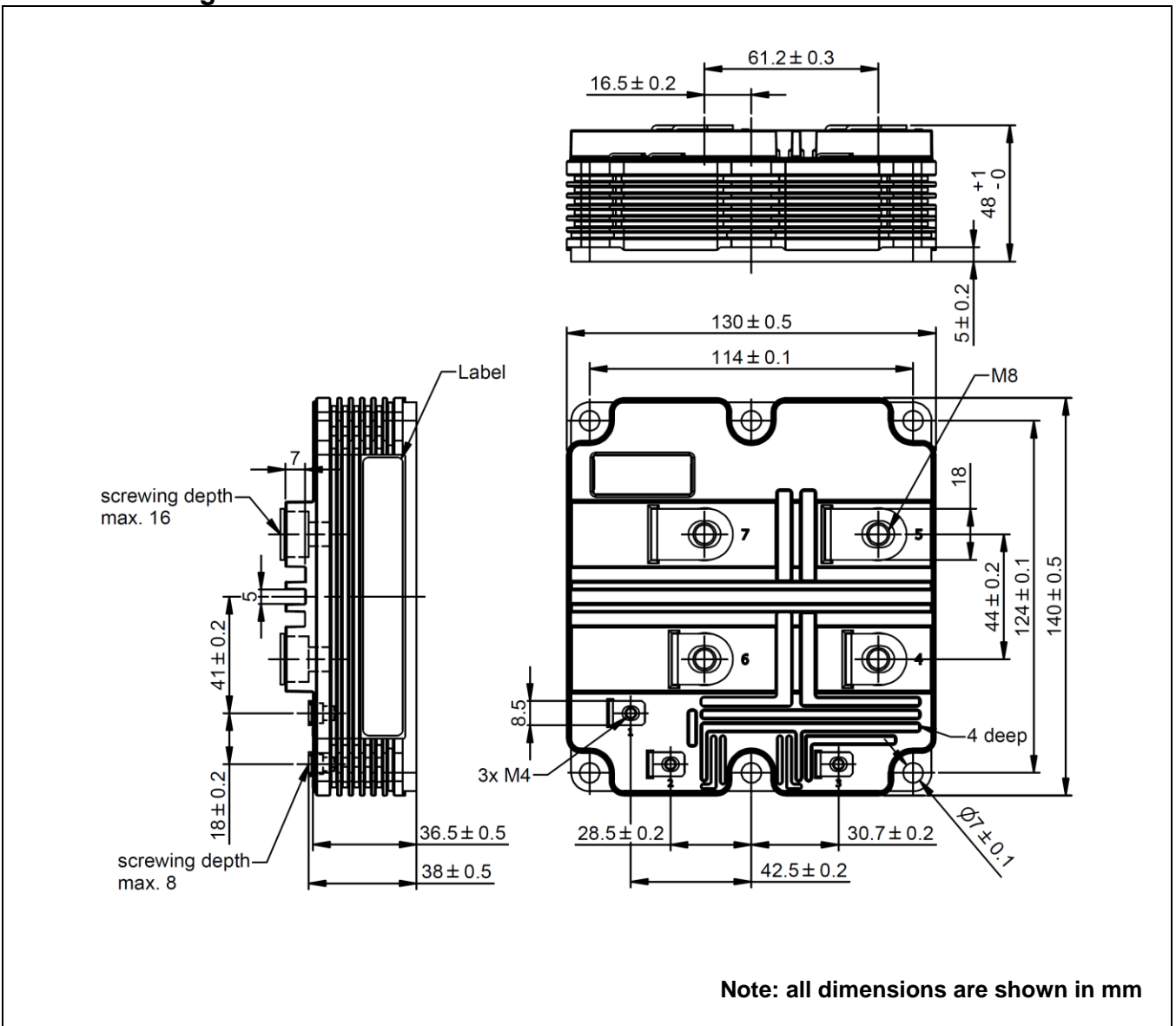

<sup>2)</sup> For detailed mounting instructions refer to ABB Document No. 5SYA2039

**This is an electrostatic sensitive device, please observe the international standard IEC 60747-1, chap. IX.**

**This product has been designed and qualified for Industrial Level.**

**ABB Switzerland Ltd, Semiconductors reserves the right to change specifications without notice.**

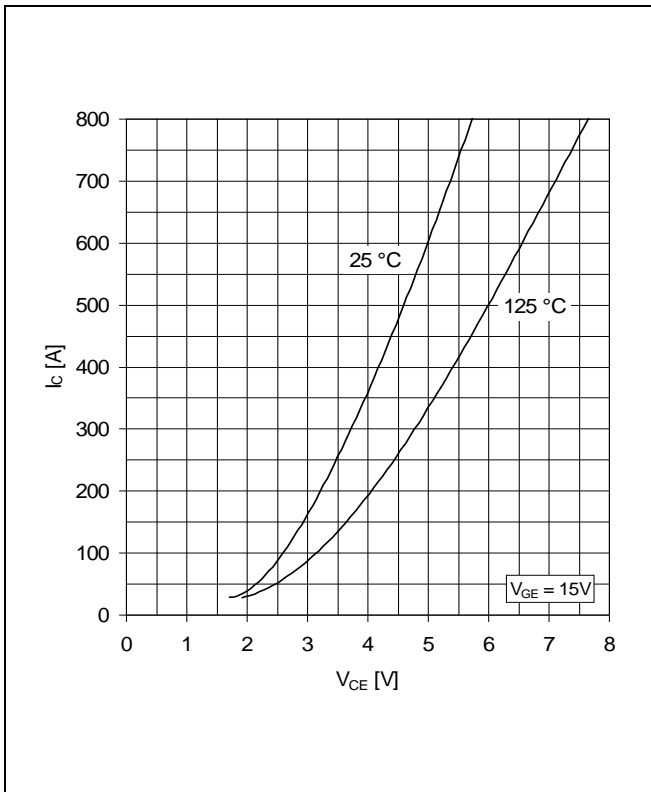

Fig. 1 Typical on-state characteristics, chip level

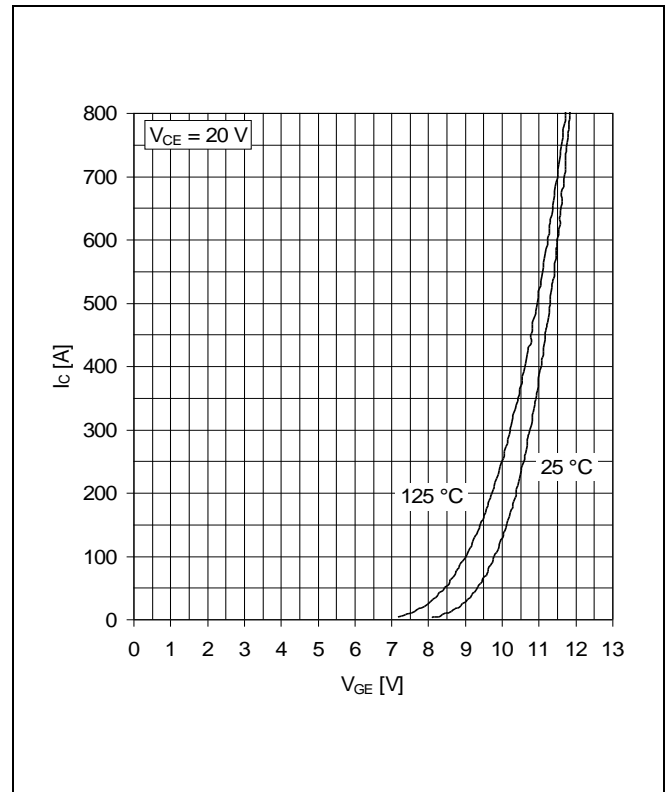

Fig. 2 Typical transfer characteristics, chip level

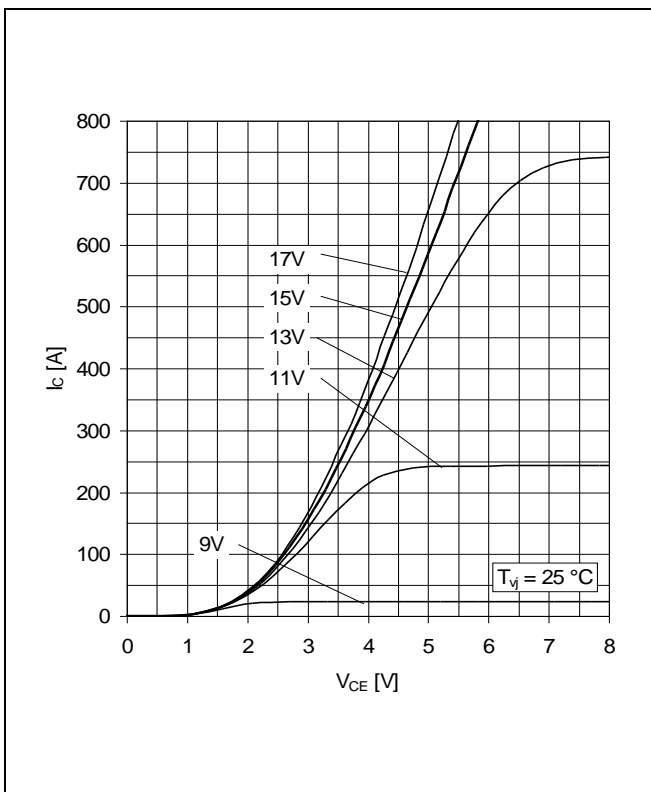

Fig. 3 Typical output characteristics, chip level

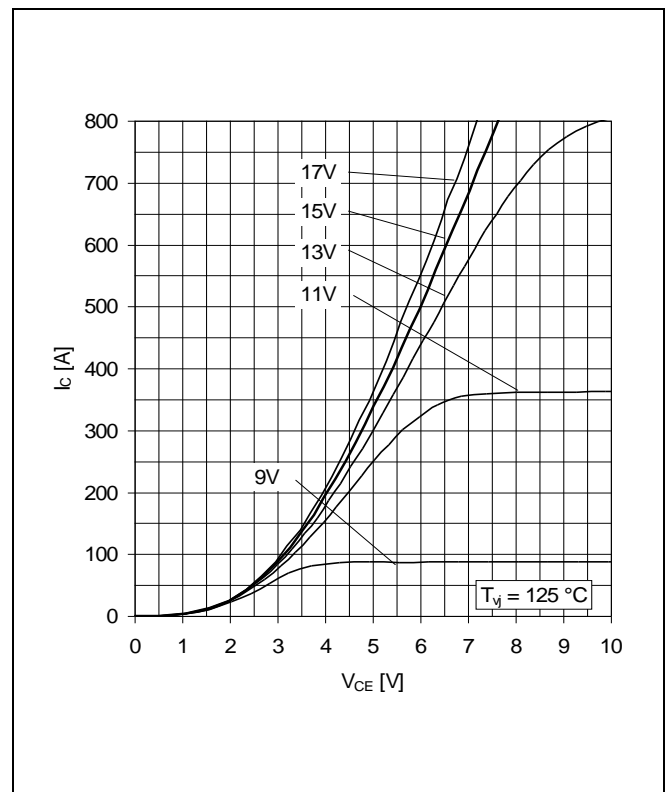
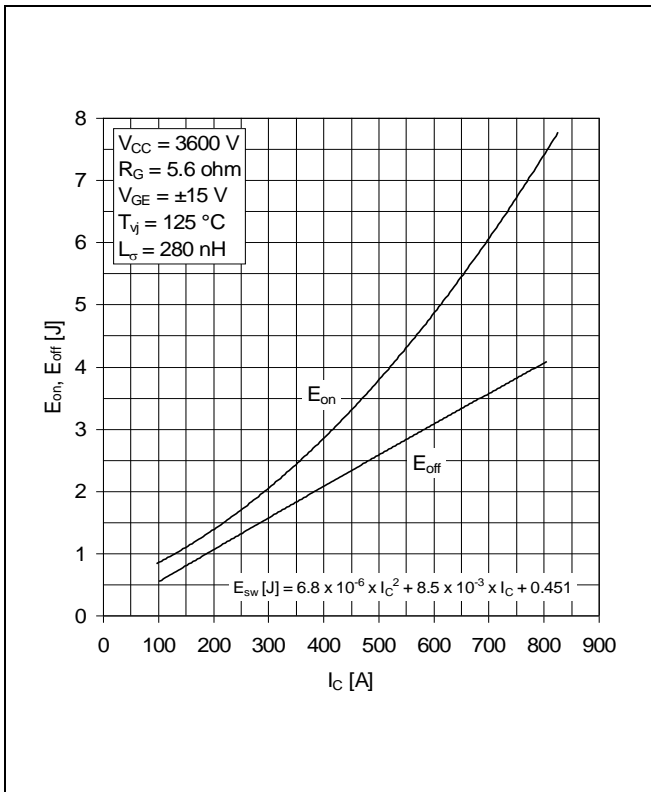
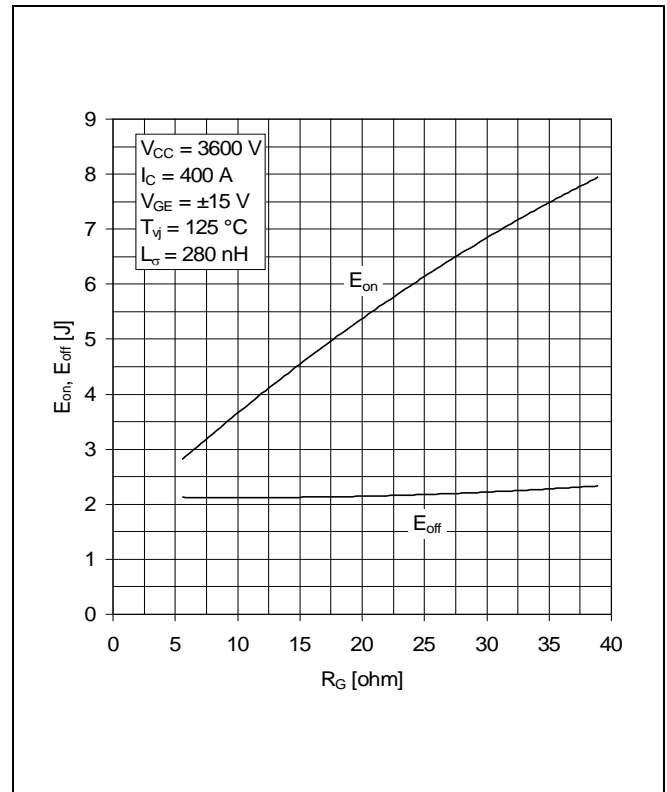

Fig. 4 Typical output characteristics, chip level



**Fig. 5** Typical switching energies per pulse vs collector current



**Fig. 6** Typical switching energies per pulse vs gate resistor

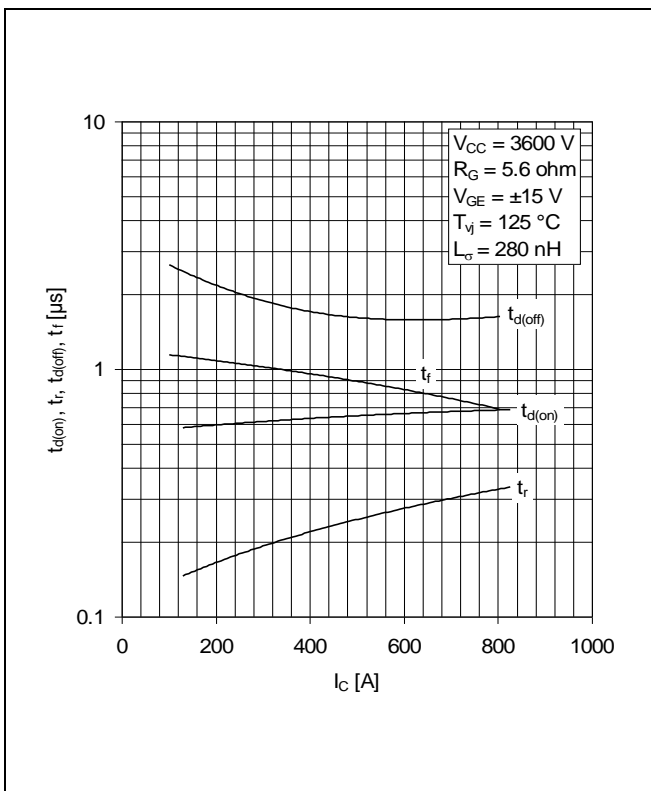

**Fig. 7** Typical switching times vs collector current

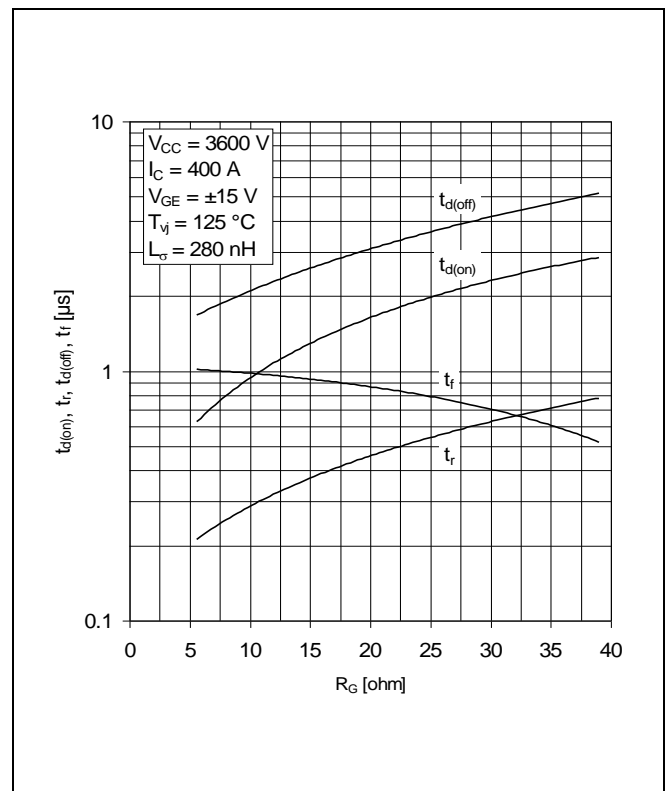

**Fig. 8** Typical switching times vs gate resistor

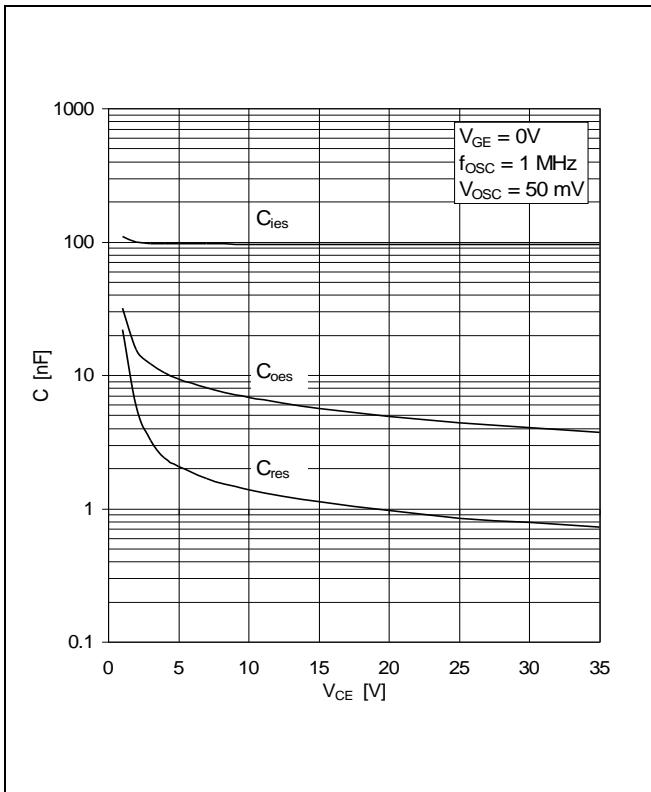

**Fig. 9** Typical capacitances vs collector-emitter voltage

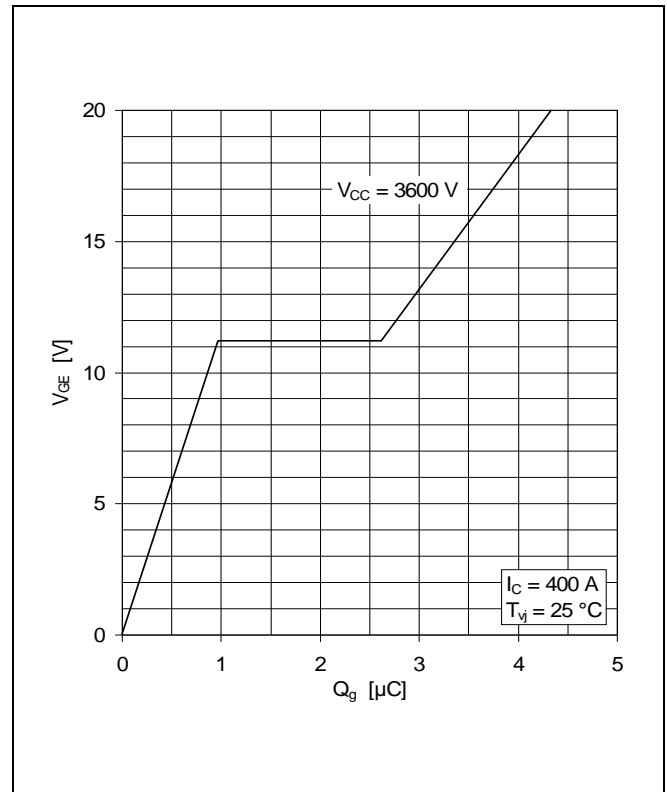

**Fig. 10** Typical gate charge characteristics

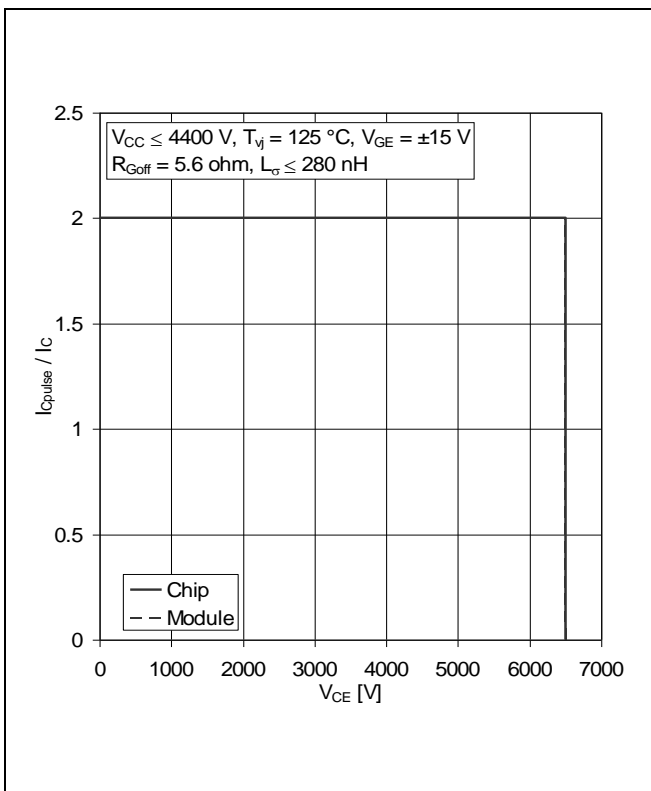

**Fig. 11** Turn-off safe operating area (RBSOA)

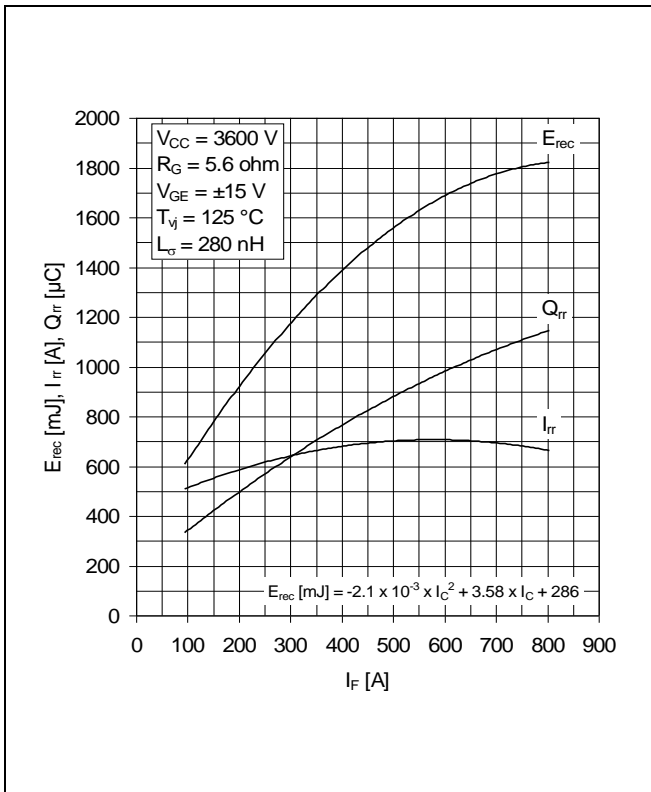

**Fig. 12** Typical reverse recovery characteristics vs forward current

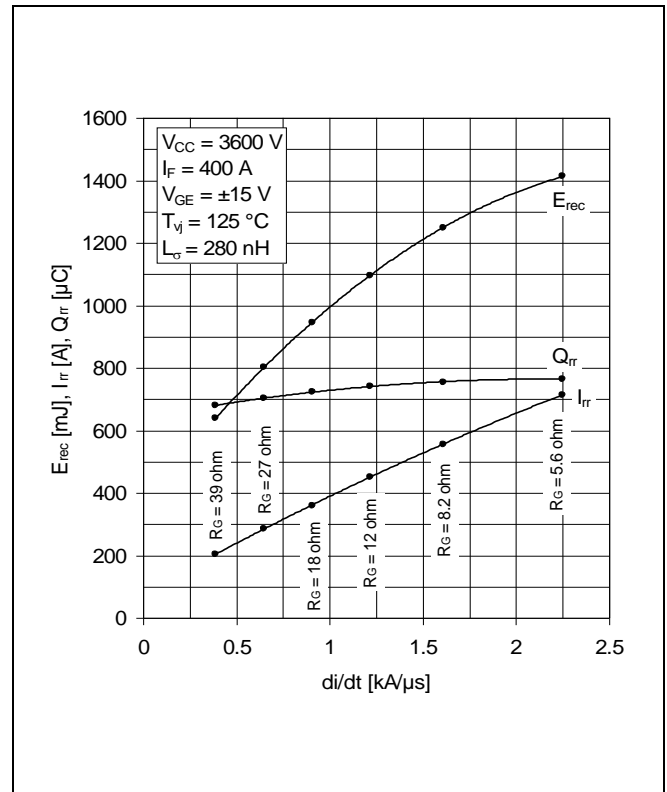

**Fig. 13** Typical reverse recovery characteristics vs di/dt

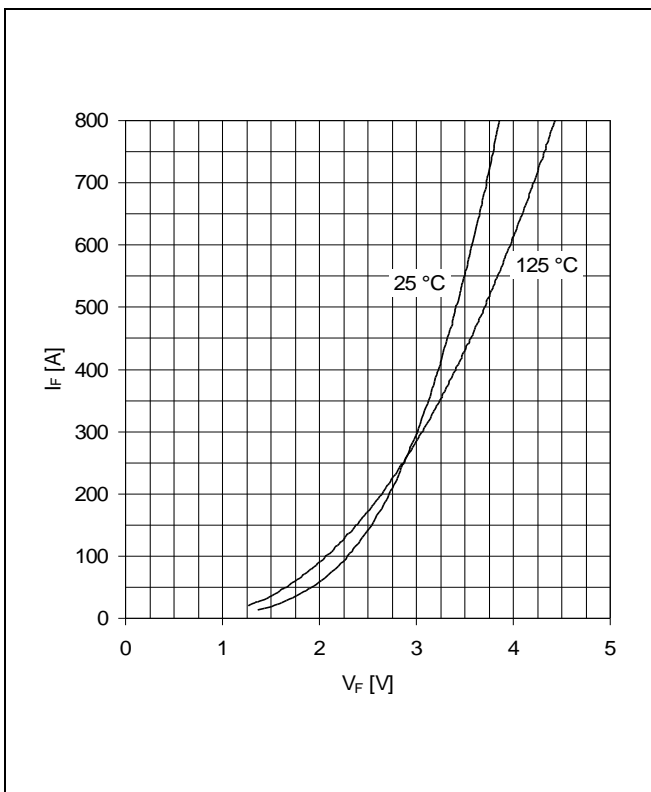

**Fig. 14** Typical diode forward characteristics, chip level

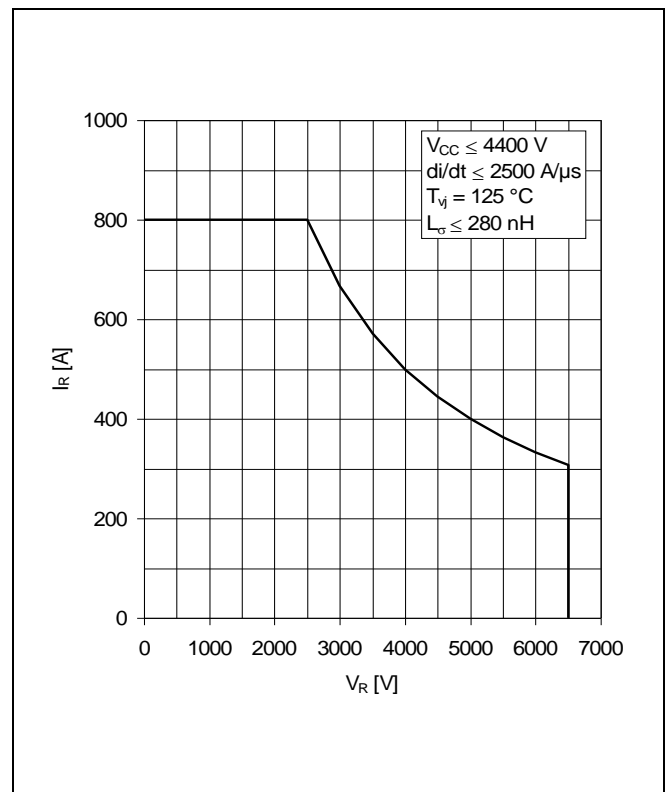

**Fig. 15** Safe operating area diode (SOA)



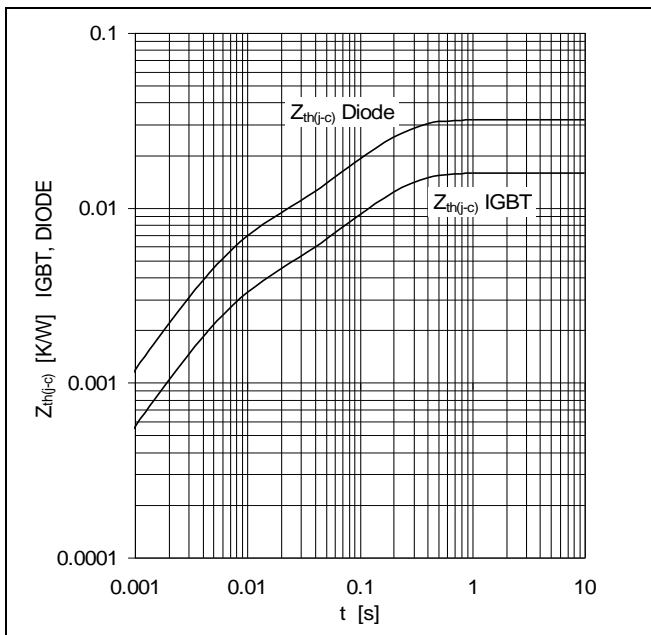

Fig. 16 Thermal impedance vs time

Analytical function for transient thermal impedance:

$$Z_{th(j-c)}(t) = \sum_{i=1}^n R_i (1 - e^{-t/\tau_i})$$

	i	1	2	3	4	5
IGBT	R <sub>i</sub> (K/kW)	12.75	2.99			
	τ <sub>i</sub> (ms)	151	5.84			
DIODE	R <sub>i</sub> (K/kW)	25.5	6.3			
	τ <sub>i</sub> (ms)	144	5.83			

**Related documents:**

5SYA 2042 Failure rates of HiPak modules due to cosmic rays  
 5SYA 2043 Load - cycle capability of HiPaks  
 5SYA 2045 Thermal runaway during blocking  
 5SYA 2053 Applying IGBT  
 5SYA 2058 Surge currents for IGBT diodes  
 5SYA 2093 Thermal design of IGBT modules  
 5SYA 2098 Paralleling of IGBT modules  
 5SZK 9111 Specification of environmental class for HiPak Storage  
 5SZK 9112 Specification of environmental class for HiPak Transportation  
 5SZK 9113 Specification of environmental class for HiPak Operation (Industry)  
 5SZK 9120 Specification of environmental class for HiPak

We reserve the right to make technical changes or to modify the contents of this document without prior notice.

We reserve all rights in this document and the information contained therein. Any reproduction or utilization of this document or parts thereof for commercial purposes without our prior written consent is forbidden.

Any liability for use of our products contrary to the instructions in this document is excluded.



**ABB Switzerland Ltd**  
**Semiconductors**  
 Fabrikstrasse 3  
 CH-5600 Lenzburg, Switzerland

Doc. No. 5SYA 1592-04 05-2016

Telephone +41 (0)58 586 1419  
 Fax +41 (0)58 586 1306  
 Email [abbsem@ch.abb.com](mailto:abbsem@ch.abb.com)  
 Internet [www.abb.com/semiconductors](http://www.abb.com/semiconductors)