

$V_{DRM}$	=	4500 V
$I_{TGQM}$	=	4000 A
$I_{TSM}$	=	$25 \times 10^3$ A
$V_{T0}$	=	2.1 V
$r_T$	=	0.58 mW
$V_{Dclink}$	=	2800 V

# Asymmetric Gate turn-off Thyristor 5SGA 40L4501

Doc. No. 5SYA1208-02 March 05

- Patented free-floating silicon technology
- Low on-state and switching losses
- Annular gate electrode
- Industry standard housing
- Cosmic radiation withstand rating

## Blocking

*Maximum rated values <sup>1)</sup>*

Parameter	Symbol	Conditions	min	typ	max	Unit
Repetitive peak off-state voltage	$V_{DRM}$	$V_{GR} \geq 2$ V			4500	V
Repetitive peak reverse voltage	$V_{RRM}$				17	V
Permanent DC voltage for 100 FIT failure rate	$V_{DC-link}$	Ambient cosmic radiation at sea level in open air.			2800	V

*Characteristic values*

Parameter	Symbol	Conditions	min	typ	max	Unit
Repetitive peak off-state current	$I_{DRM}$	$V_D = V_{DRM}, V_{GR} \geq 2$ V			100	mA
Repetitive peak reverse current	$I_{RRM}$	$V_R = V_{RRM}, R_{GK} = \infty \Omega$			50	mA

## Mechanical data

*Maximum rated values <sup>1)</sup>*

Parameter	Symbol	Conditions	min	typ	max	Unit
Mounting force	$F_m$		36	40	44	kN

*Characteristic values*

Parameter	Symbol	Conditions	min	typ	max	Unit
Pole-piece diameter	$D_p$	$\pm 0.1$ mm		85		mm
Housing thickness	H		25.6		26.1	mm
Weight	m				1.5	kg
Surface creepage distance	$D_s$	Anode to Gate	33			mm
Air strike distance	$D_a$	Anode to Gate	14			mm

1) Maximum rated values indicate limits beyond which damage to the device may occur

ABB Switzerland Ltd, Semiconductors reserves the right to change specifications without notice.



## GTO Data

### On-state

Maximum rated values <sup>1)</sup>

Parameter	Symbol	Conditions	min	typ	max	Unit
Max. average on-state current	$I_{T(AV)M}$	Half sine wave, $T_C = 85^\circ\text{C}$			1000	A
Max. RMS on-state current	$I_{T(RMS)}$				1570	A
Max. peak non-repetitive surge current	$I_{TSM}$	$t_p = 10\text{ ms}$ , $T_{vj} = 125^\circ\text{C}$ , sine wave After Surge: $V_D = V_R = 0\text{ V}$			$25 \times 10^3$	A
Limiting load integral	$I^2t$				$3.1 \times 10^6$	$\text{A}^2\text{s}$
Max. peak non-repetitive surge current	$I_{TSM}$	$t_p = 1\text{ ms}$ , $T_{vj} = 125^\circ\text{C}$ , sine wave After Surge: $V_D = V_R = 0\text{ V}$			$40 \times 10^3$	A
Limiting load integral	$I^2t$				$800 \times 10^3$	$\text{A}^2\text{s}$

Characteristic values

Parameter	Symbol	Conditions	min	typ	max	Unit
On-state voltage	$V_T$	$I_T = 4000\text{ A}$ , $T_{vj} = 125^\circ\text{C}$			4.4	V
Threshold voltage	$V_{(T0)}$	$T_{vj} = 125^\circ\text{C}$			2.1	V
Slope resistance	$r_T$	$I_T = 400 \dots 5000\text{ A}$			0.58	$\text{m}\Omega$
Holding current	$I_H$	$T_{vj} = 25^\circ\text{C}$			100	A

### Turn-on switching

Maximum rated values <sup>1)</sup>

Parameter	Symbol	Conditions	min	typ	max	Unit
Critical rate of rise of on-state current	$di_T/dt_{cr}$	$T_{vj} = 125^\circ\text{C}$ , $f = 200\text{ Hz}$ $I_T = 4000\text{ A}$ , $I_{GM} = 50\text{ A}$			500	$\text{A}/\mu\text{s}$
Critical rate of rise of on-state current	$di_T/dt_{cr}$	$di_G/dt = 40\text{ A}/\mu\text{s}$ , $f = 1\text{ Hz}$			1000	$\text{A}/\mu\text{s}$
Min. on-time	$t_{on}$	$V_D = 0.5 V_{DRM}$ , $T_{vj} = 125^\circ\text{C}$ $I_T = 4000\text{ A}$ , $di/dt = 300\text{ A}/\mu\text{s}$ , $I_{GM} = 50\text{ A}$ , $di_G/dt = 40\text{ A}/\mu\text{s}$ , $C_S = 6\text{ }\mu\text{F}$ , $R_S = 5\text{ }\Omega$	100			$\mu\text{s}$

Characteristic values

Parameter	Symbol	Conditions	min	typ	max	Unit
Turn-on delay time	$t_d$	$V_D = 0.5 V_{DRM}$ , $T_{vj} = 125^\circ\text{C}$ $I_T = 4000\text{ A}$ , $di/dt = 300\text{ A}/\mu\text{s}$ ,			2.5	$\mu\text{s}$
Rise time	$t_r$	$I_{GM} = 50\text{ A}$ , $di_G/dt = 40\text{ A}/\mu\text{s}$ ,			5	$\mu\text{s}$
Turn-on energy per pulse	$E_{on}$	$C_S = 6\text{ }\mu\text{F}$ , $R_S = 5\text{ }\Omega$			3.3	J

### Turn-off switching

Maximum rated values <sup>1)</sup>

Parameter	Symbol	Conditions	min	typ	max	Unit
Max. controllable turn-off current	$I_{TGQM}$	$V_{DM} \leq V_{DRM}$ , $di_{GQ}/dt = 40\text{ A}/\mu\text{s}$ , $C_S = 6\text{ }\mu\text{F}$ , $L_S \leq 0.3\text{ }\mu\text{H}$			4000	A
Min. off-time	$t_{off}$	$V_D = 0.5 V_{DRM}$ , $T_{vj} = 125^\circ\text{C}$ $V_{DM} \leq V_{DRM}$ , $di_{GQ}/dt = 40\text{ A}/\mu\text{s}$ , $I_{TGQ} = I_{TGQM}$ , $R_S = 5\text{ }\Omega$ , $C_S = 6\text{ }\mu\text{F}$ , $L_S = 0.3\text{ }\mu\text{H}$	100			$\mu\text{s}$

Characteristic values

Parameter	Symbol	Conditions	min	typ	max	Unit
Storage time	$t_S$	$V_D = 0.5 V_{DRM}$ , $T_{vj} = 125^\circ\text{C}$			27	$\mu\text{s}$
Fall time	$t_f$	$V_{DM} \leq V_{DRM}$ , $di_{GQ}/dt = 40\text{ A}/\mu\text{s}$ , $I_{TGQ} = I_{TGQM}$ ,			3	$\mu\text{s}$
Turn-on energy per pulse	$E_{off}$	$R_S = 5\text{ }\Omega$ , $C_S = 6\text{ }\mu\text{F}$ , $L_S = 0.3\text{ }\mu\text{H}$			14	J
Peak turn-off gate current	$I_{GQM}$				1100	A

## Gate

Maximum rated values <sup>1)</sup>

Parameter	Symbol	Conditions	min	typ	max	Unit
Repetitive peak reverse voltage	V <sub>GRM</sub>				17	V
Repetitive peak reverse current	I <sub>GRM</sub>	V <sub>GR</sub> = V <sub>GRM</sub>			50	mA

Characteristic values

Parameter	Symbol	Conditions	min	typ	max	Unit
Gate trigger voltage	V <sub>GT</sub>	T <sub>vj</sub> = 25°C,		1.2		V
Gate trigger current	I <sub>GT</sub>	V <sub>D</sub> = 24 V, R <sub>A</sub> = 0.1 Ω		4		A

## Thermal

Maximum rated values <sup>1)</sup>

Parameter	Symbol	Conditions	min	typ	max	Unit
Junction operating temperature	T <sub>vj</sub>		-40		125	°C
Storage temperature range	T <sub>stg</sub>		-40		125	°C

Characteristic values

Parameter	Symbol	Conditions	min	typ	max	Unit
Thermal resistance junction to case	R <sub>th(j-c)</sub>	Double side cooled			11	K/kW
	R <sub>th(j-c)A</sub>	Anode side cooled			20	K/kW
	R <sub>th(j-c)C</sub>	Cathode side cooled			25	K/kW
Thermal resistance case to heatsink (Double side cooled)	R <sub>th(c-h)</sub>	Single side cooled			6	K/kW
	R <sub>th(c-h)</sub>	Double side cooled			3	K/kW

Analytical function for transient thermal impedance:

$$Z_{th(j-c)}(t) = \sum_{i=1}^n R_i(1 - e^{-t/\tau_i})$$

i	1	2	3	4
R <sub>i</sub> (K/kW)	7.313	1.974	1.218	0.501
τ <sub>i</sub> (s)	0.5400	0.0939	0.0117	0.0036

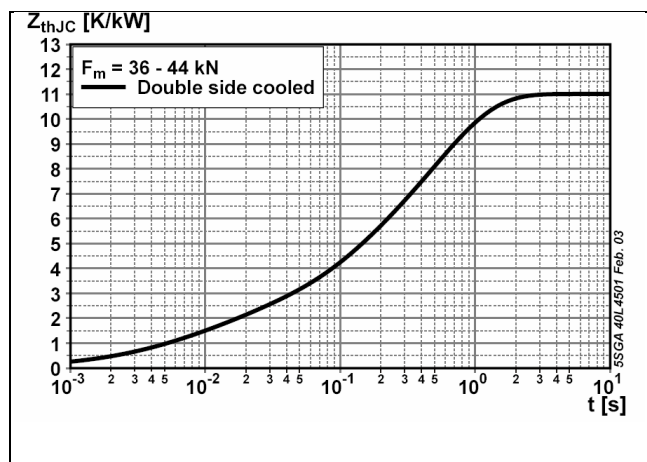

Fig. 1 Transient thermal impedance, junction to case

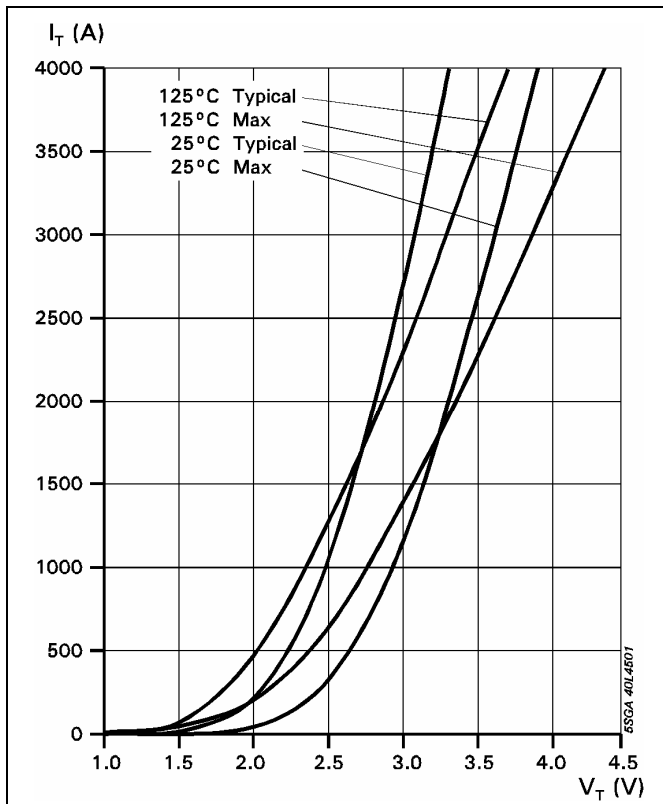

Fig. 2 On-state characteristics

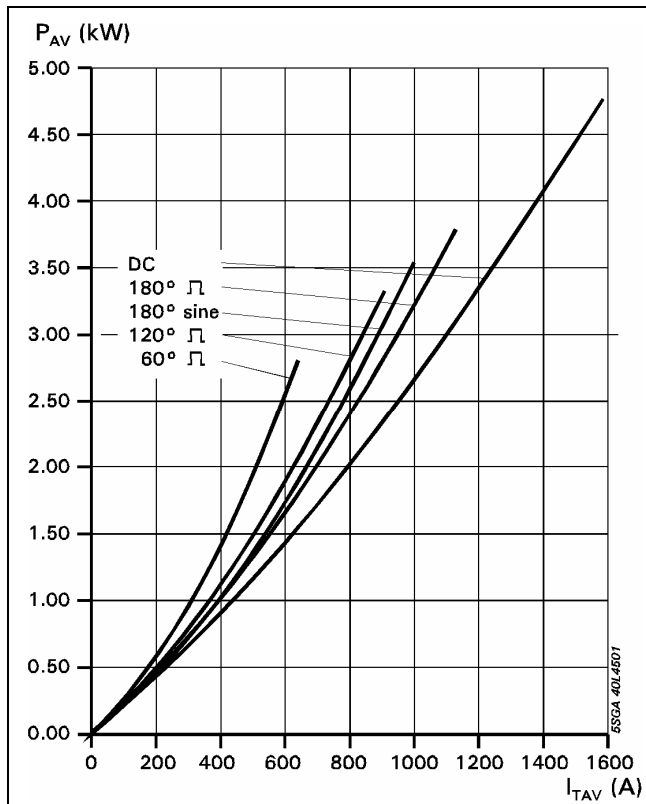

Fig. 3 Average on-state power dissipation vs. average on-state current

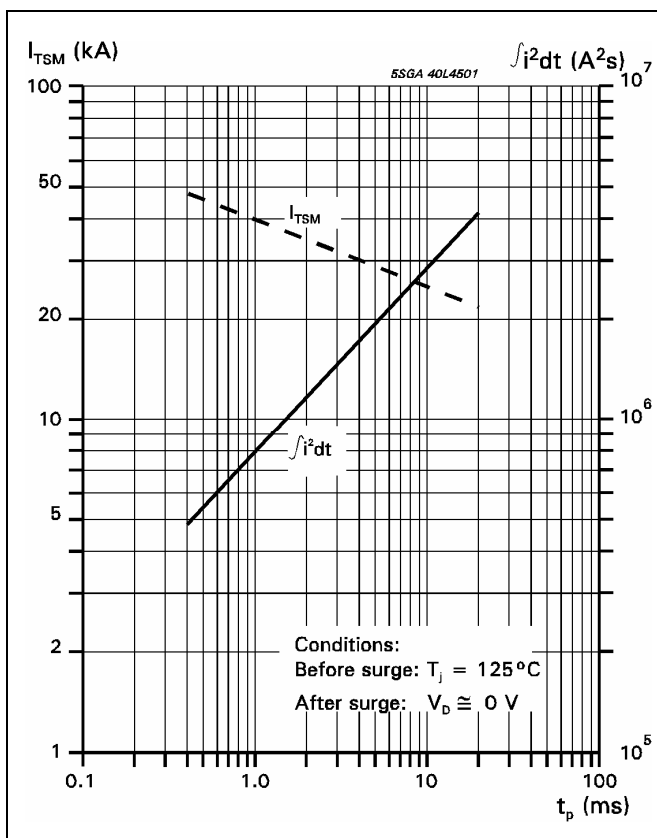

Fig. 4 Surge current and fusing integral vs. pulse width

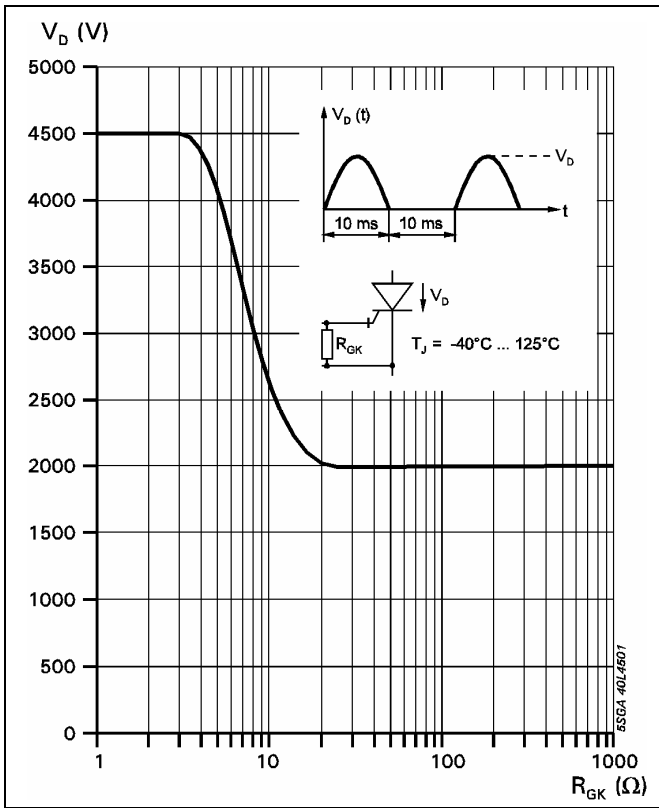

Fig. 5 Forward blocking voltage vs. gate-cathode resistance

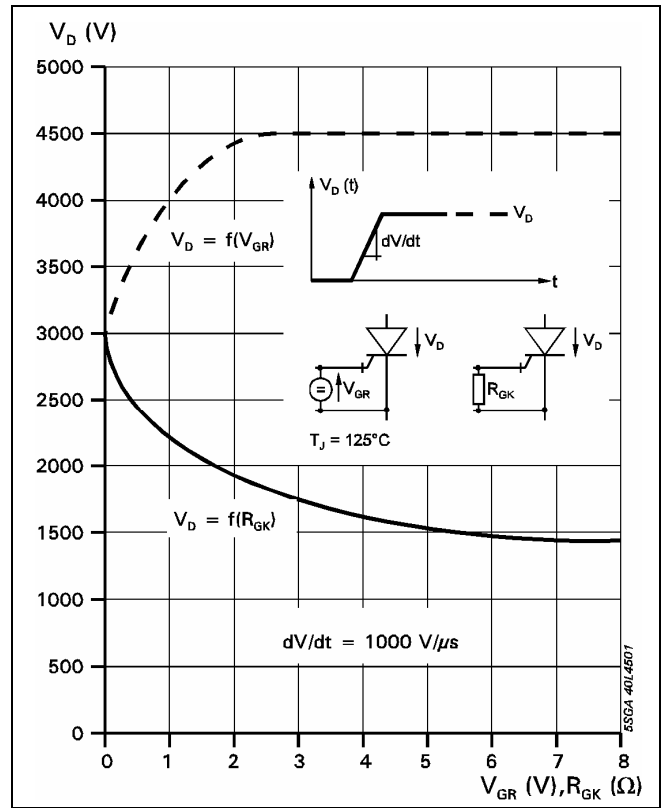

Fig. 6 Static dv/dt capability; forward blocking voltage vs. neg. gate voltage or gate cathode resistance

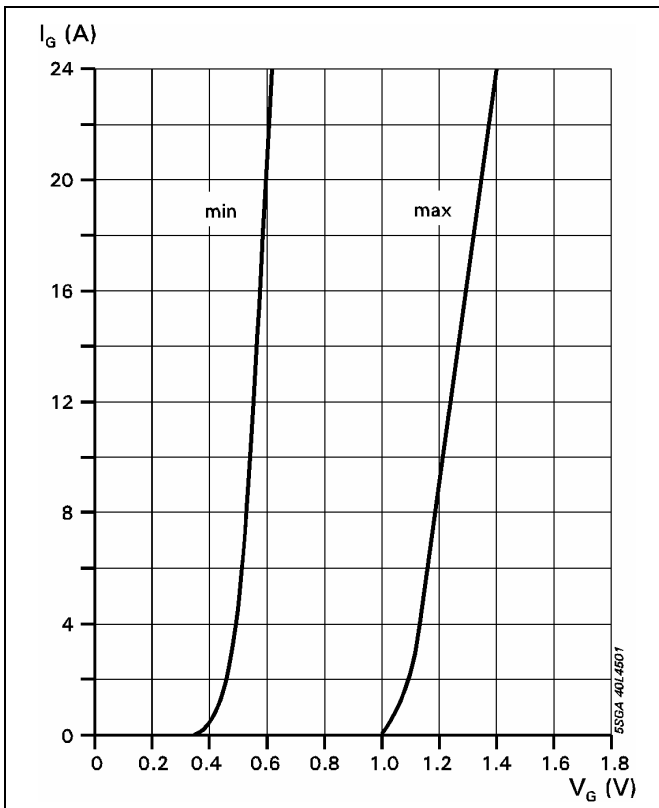

Fig. 7 Forward gate current vs. forward gate voltage

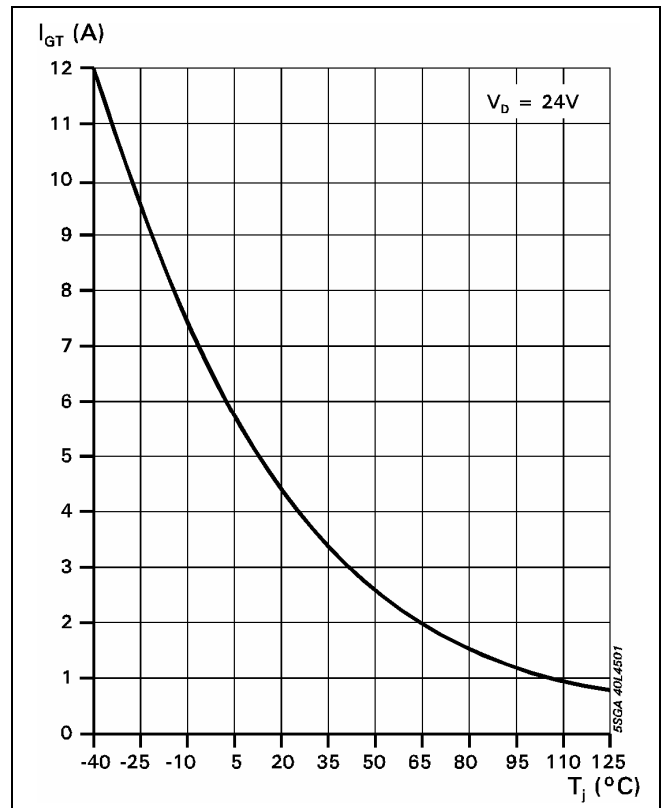

Fig. 8 Gate trigger current vs. junction temperature

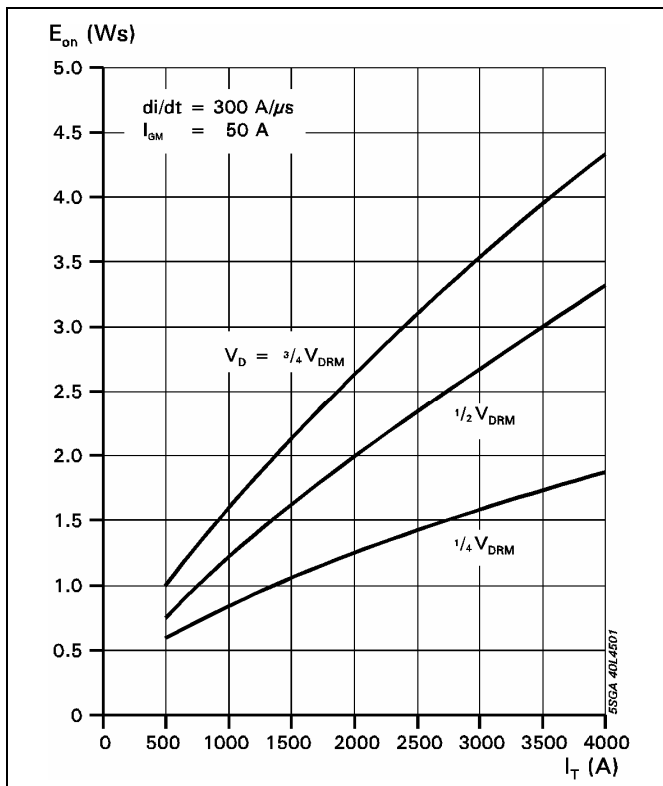

Fig. 9 Turn-on energy per pulse vs. on-state current and turn-on voltage

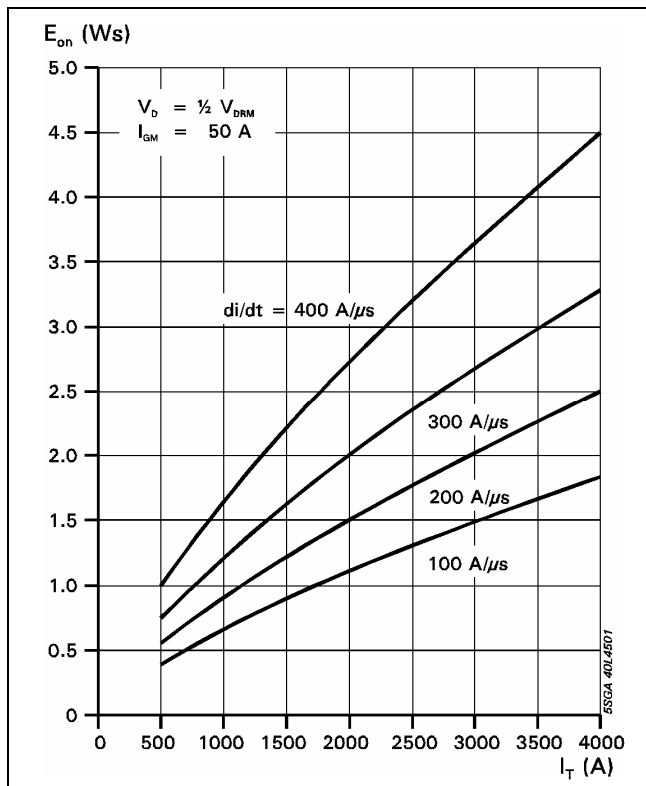

Fig. 10 Turn-on energy per pulse vs. on-state current and current rise rate

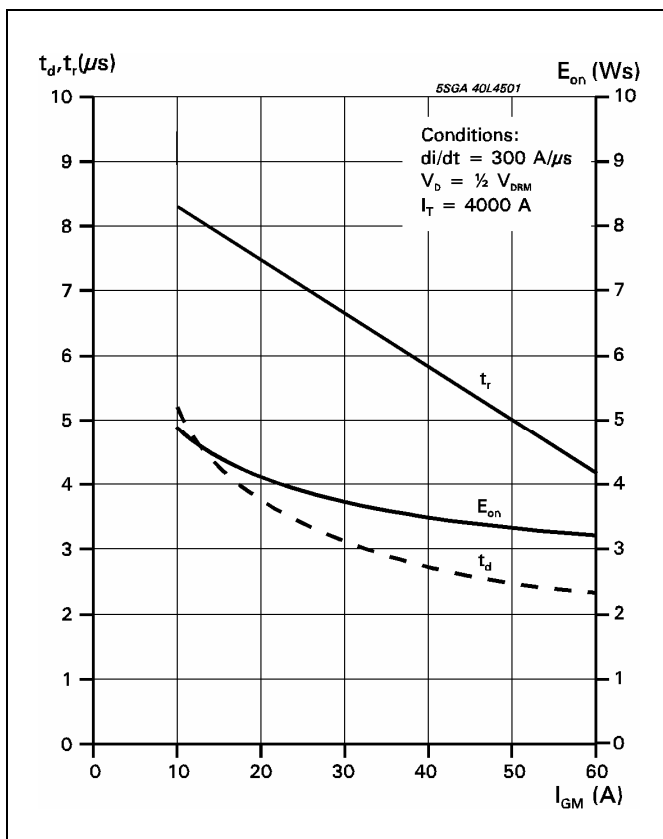

Fig. 11 Turn-on energy per pulse vs. on-state current and turn-on voltage

Common Test conditions:

- $di_G/dt = 40 \text{ A}/\mu\text{s}$
- $C_S = 6 \mu\text{F}$
- $R_S = 5 \Omega$
- $T_j = 125 \text{ }^\circ\text{C}$

Definition of Turn-on energy:

$$E_{on} = \int_0^{20 \text{ ms}} V_D \cdot I_T dt \quad (t = 0, I_G = 0.1 \cdot I_{GM})$$

Definition of Turn-off energy:

$$E_{off} = \int_0^{40 \text{ ns}} V_D \cdot I_T dt \quad (t = 0, I_T = 0.9 \cdot I_{TQ})$$

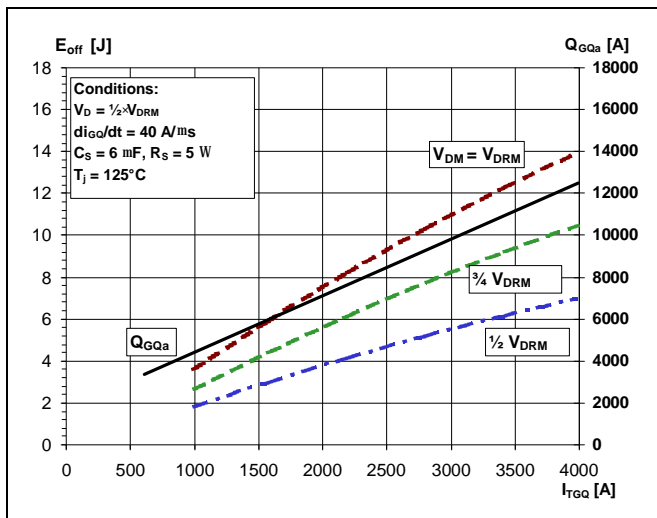

**Fig. 12** Turn-off energy per pulse vs. turn-off current and peak turn-off voltage, extracted gate charge vs. turn-off current

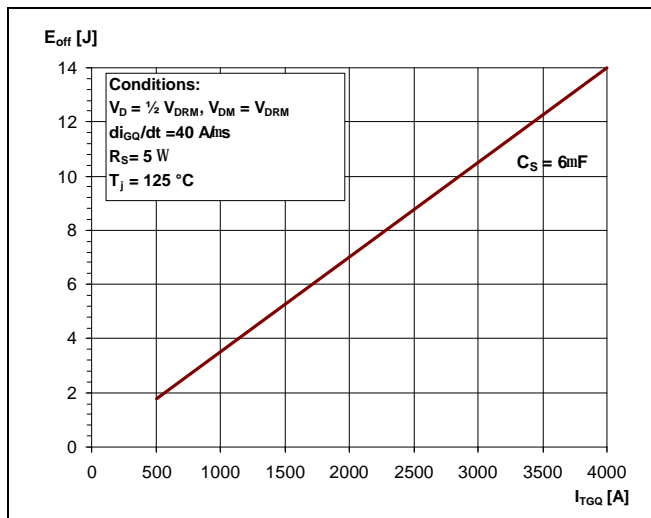

**Fig. 13** Turn-off energy per pulse vs. turn-off current and snubber capacitance

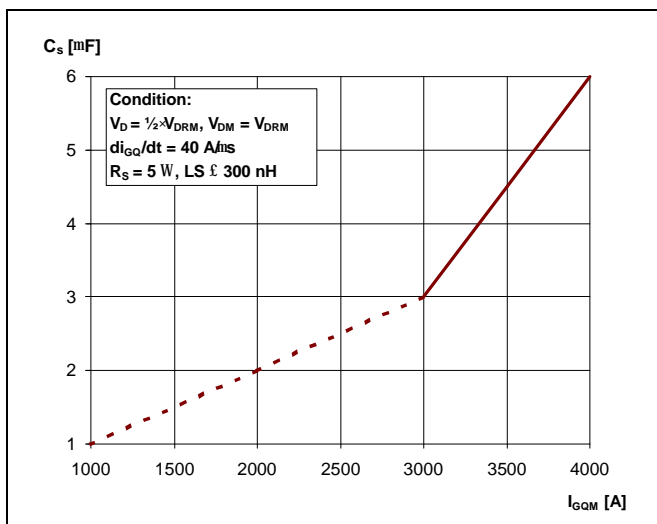

**Fig. 14** Required snubber capacitor vs. max allowable turn-off current

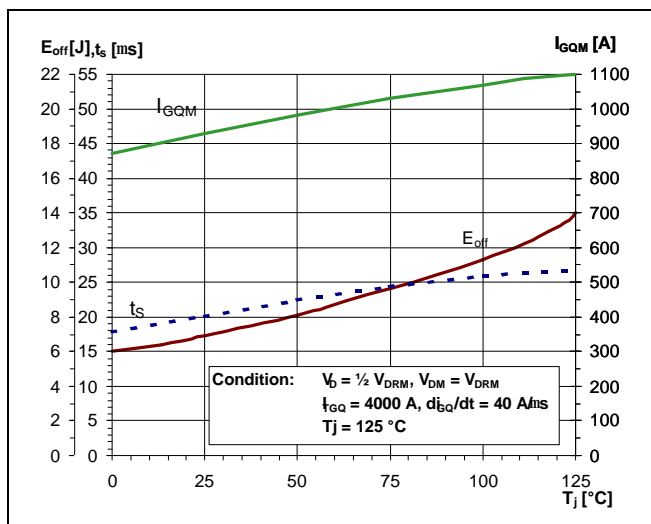

**Fig. 15** Turn-off energy per pulse, storage time and peak turn-off gate current vs. junction temperature

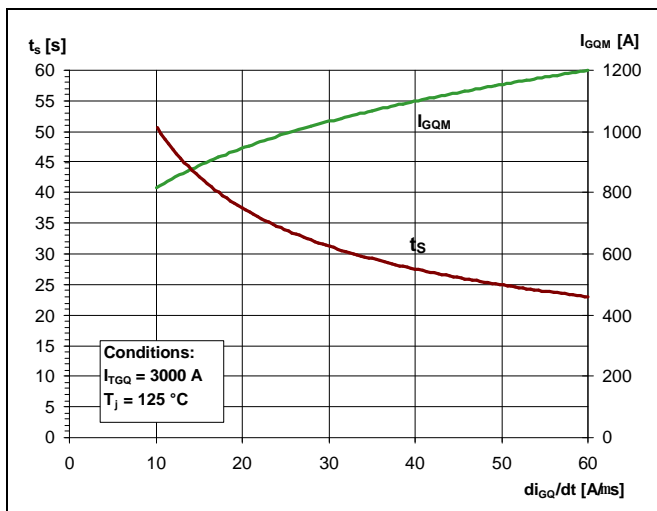

**Fig. 16** Storage time and peak turn-off gate current vs. neg. gate current rise rate

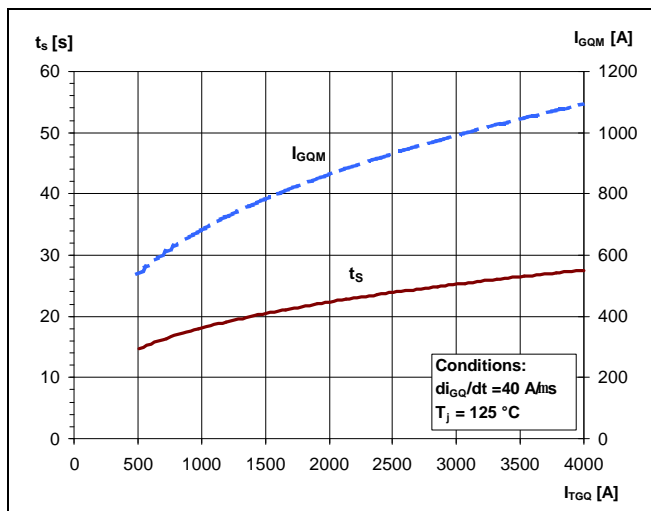

**Fig. 17** Storage time and peak turn-off gate current vs. turn-off current

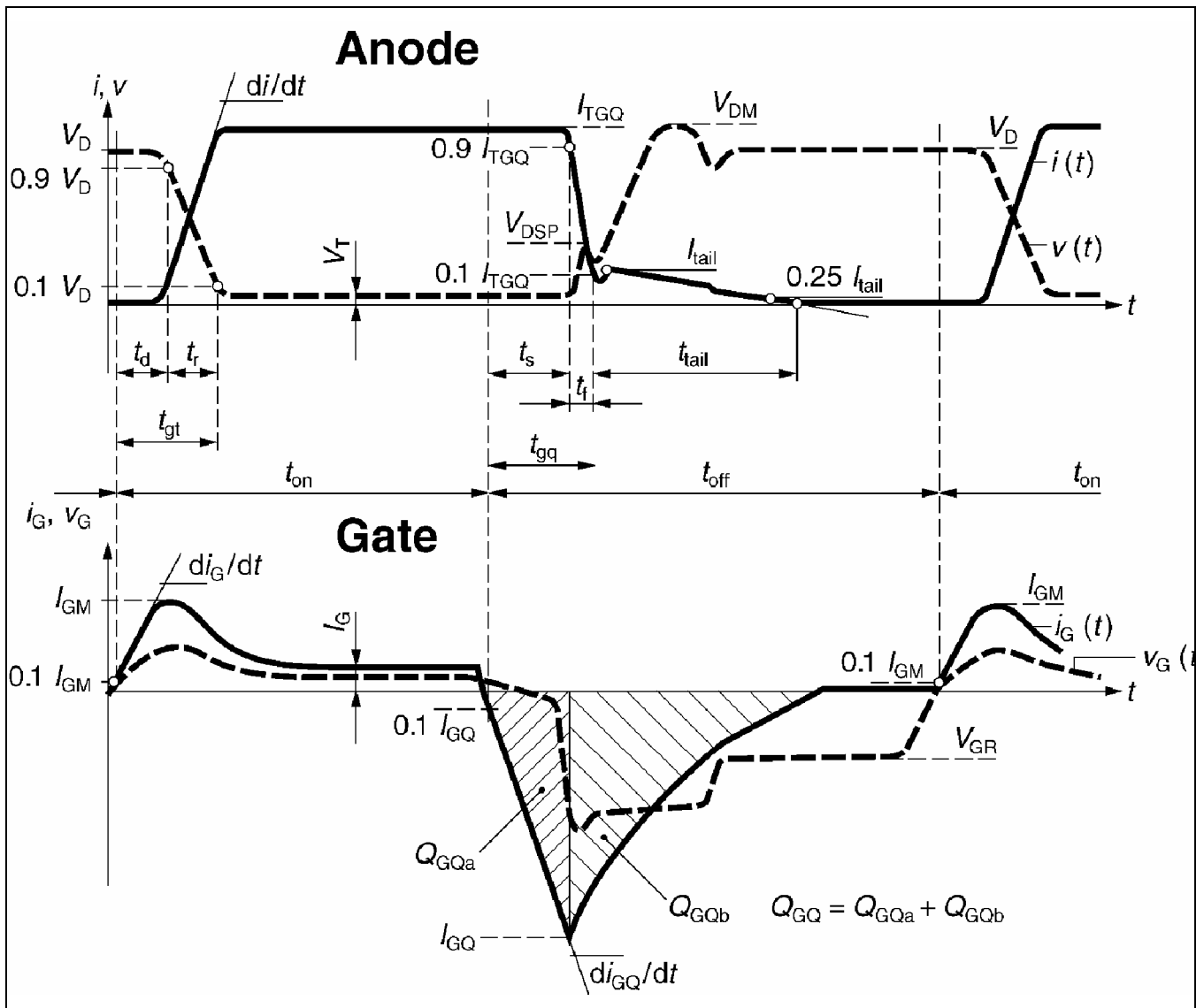
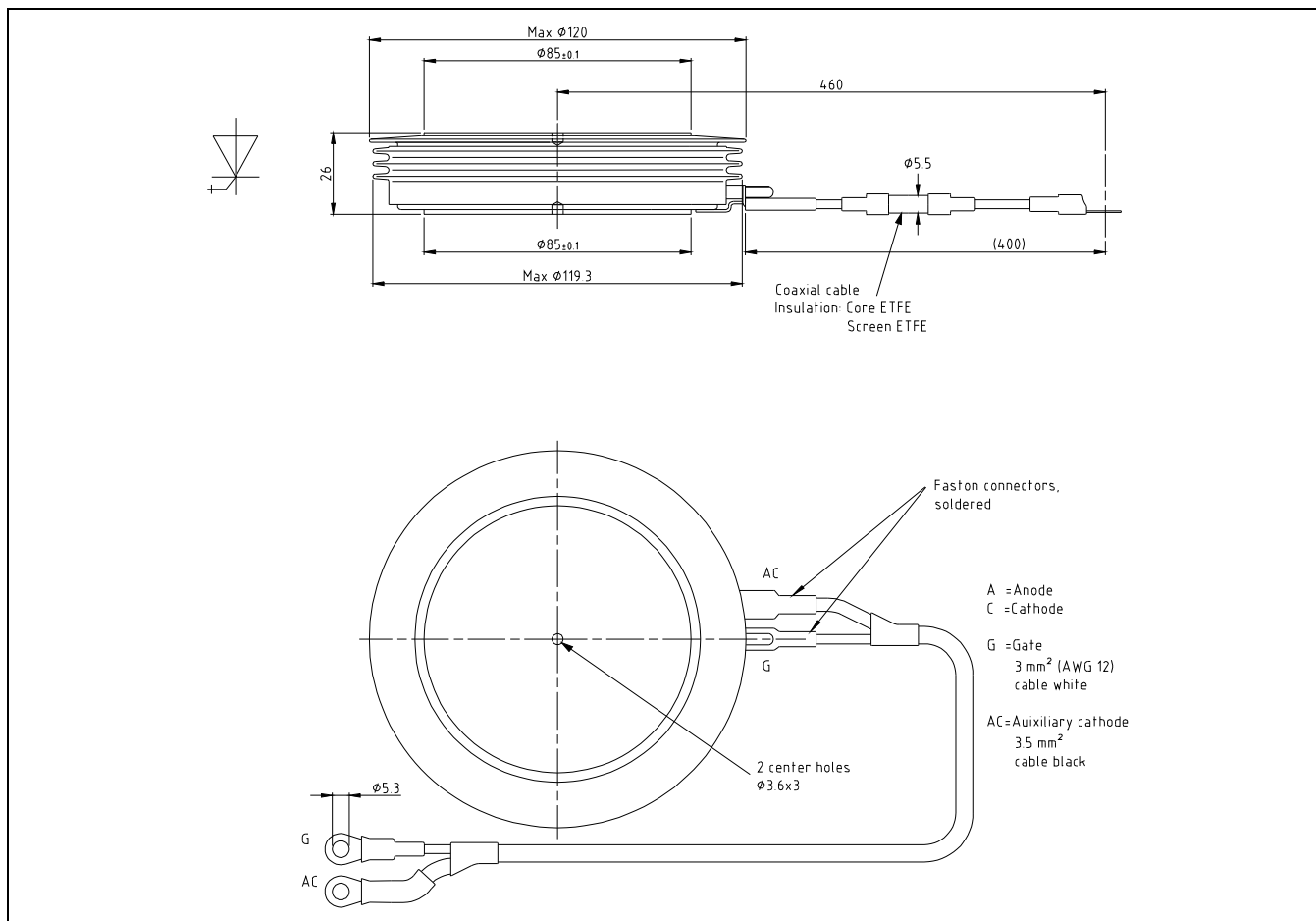

Fig. 18 General current and voltage waveforms with GTO-specific symbols





**Fig. 19** Outline drawing; all dimensions are in millimeters and represent nominal values unless stated otherwise

### Reverse avalanche capability

In operation with an antiparallel freewheeling diode, the GTO reverse voltage  $V_R$  may exceed the rate value  $V_{RRM}$  due to stray inductance and diode turn-on voltage spike at high  $di/dt$ . The GTO is then driven into reverse avalanche. This condition is not dangerous for the GTO provided avalanche time and current are below  $10 \mu s$  and 1000 A respectively. However, gate voltage must remain negative during this time. Recommendation :  $V_{GR} = 10 \dots 15 V$ .

### Related documents:

5SYA 2036	Recommendations regarding mechanical clamping of Press Pack High Power Semiconductors
5SYA 2046	Cosmic Ray
5SZK 9104	Specification of enviromental class for pressure contact GTO, STORAGE available on request, please contact factory
5SZK 9105	Specification of enviromental class for pressure contact GTO, TRANSPORTATION available on request, please contact factory

Please refer to <http://www.abb.com/semiconductors> for actual versions.

**ABB Switzerland Ltd, Semiconductors reserves the right to change specifications without notice.**



**ABB Switzerland Ltd**  
**Semiconductors**  
 Fabrikstrasse 3  
 CH-5600 Lenzburg, Switzerland

Doc. No. 5SYA1208-02 March 05

Telephone +41 (0)58 586 1419  
 Fax +41 (0)58 586 1306  
 Email [abbsem@ch.abb.com](mailto:abbsem@ch.abb.com)  
 Internet [www.abb.com/semiconductors](http://www.abb.com/semiconductors)