

V_{RRM}	=	4500 V
$I_{F(AV)M}$	=	1440 A
I_{FSM}	=	25×10^3 A
$V_{(T0)}$	=	1.75 V
r_T	=	0.88 mW
V_{DClink}	=	2800 V

Fast Recovery Diode

5SDF 10H4520

Doc. No. 5SYA1170-00 March 05

- Low temperature bonding technology
- Industry standard housing
- Cosmic radiation withstand rating
- Low on-state and switching losses
- Optimized for snubberless operation

Blocking

Maximum rated values ¹⁾

Parameter	Symbol	Conditions	Value	Unit
Repetitive peak reverse voltage	V_{RRM}	$f = 50$ Hz, $t_p = 10$ ms, $T_{vj} = 140^\circ\text{C}$	4500	V
Permanent DC voltage for 100 FIT failure rate	V_{DClink}	Ambient cosmic radiation at sea level in open air. (100% Duty)	2800	V
Permanent DC voltage for 100 FIT failure rate	V_{DClink}	Ambient cosmic radiation at sea level in open air. (5% Duty)	3200	V

Characteristic values

Parameter	Symbol	Conditions	min	typ	max	Unit
Repetitive peak reverse current	I_{RRM}	$V_R = V_{RRM}$, $T_{vj} = 140^\circ\text{C}$			100	mA

Mechanical data

Maximum rated values ¹⁾

Parameter	Symbol	Conditions	min	typ	max	Unit
Mounting force	F_m		36	40	46	kN
Acceleration	a	Device unclamped			50	m/s^2
Acceleration	a	Device clamped			200	m/s^2

Characteristic values

Parameter	Symbol	Conditions	min	typ	max	Unit
Weight	m				0.83	kg
Housing thickness	H		25.8		26.1	mm
Surface creepage distance	D_s		33			mm
Air strike distance	D_a		20			mm

1) Maximum rated values indicate limits beyond which damage to the device may occur

ABB Switzerland Ltd, Semiconductors reserves the right to change specifications without notice.



On-state

Maximum rated values ¹⁾

Parameter	Symbol	Conditions	min	typ	max	Unit
Max. average on-state current	$I_{F(AV)M}$	Half sine wave, $T_C = 70\text{ °C}$			1440	A
Max. RMS on-state current	$I_{F(RMS)}$				2260	A
Max. peak non-repetitive surge current	I_{FSM}	$t_p = 10\text{ ms}$, $T_{vj} = 140\text{ °C}$, $V_R = 0\text{ V}$			25×10^3	A
Limiting load integral	I^2t				3.12×10^6	A ² s
Max. peak non-repetitive surge current	I_{FSM}	$t_p = 30\text{ ms}$, $T_{vj} = 140\text{ °C}$, $V_R = 0\text{ V}$			16×10^3	A
Limiting load integral	I^2t				3.84×10^6	A ² s

Characteristic values

Parameter	Symbol	Conditions	min	typ	max	Unit
On-state voltage	V_F	$I_F = 2500\text{ A}$, $T_{vj} = 140\text{ °C}$		3.1	3.8	V
Threshold voltage	$V_{(T0)}$	$T_{vj} = 140\text{ °C}$			1.75	V
Slope resistance	r_T	$I_F = 500\text{...}2500\text{ A}$			0.88	mΩ

Turn-on

Characteristic values

Parameter	Symbol	Conditions	min	typ	max	Unit
Peak forward recovery voltage	V_{FRM}	$di_F/dt = 600\text{ A}/\mu\text{s}$, $T_{vj} = 140\text{ °C}$			80	V
		$di_F/dt = 3000\text{ A}/\mu\text{s}$, $T_{vj} = 140\text{ °C}$			250	V

Turn-off

Maximum rated values ¹⁾

Parameter	Symbol	Conditions	min	typ	max	Unit
Max. decay rate of on-state current	di/dt_{crit}	$I_{FM} = 4000\text{ A}$, $T_{vj} = 140\text{ °C}$ $V_{DClink} = 2800\text{ V}$			600	A/ μs

Characteristic values

Parameter	Symbol	Conditions	min	typ	max	Unit
Reverse recovery current	I_{RM}	$I_{FM} = 3300\text{ A}$, $V_{DC-Link} = 2800\text{ V}$			1600	A
Reverse recovery charge	Q_{rr}	$-di_F/dt = 600\text{ A}/\mu\text{s}$, $L_{CL} = 300\text{ nH}$			5600	μC
Turn-off energy	E_{rr}	$C_{CL} = 10\text{ }\mu\text{F}$, $R_{CL} = 0.65\text{ }\Omega$, $T_{vj} = 140\text{ °C}$, $D_{CL} = 5\text{SDF } 10\text{H}4520$			9.5	J

Thermal

Maximum rated values ¹⁾

Parameter	Symbol	Conditions	min	typ	max	Unit
Operating junction temperature range	T_{vj}		0		140	°C
Storage temperature range	T_{stg}		-40		140	°C

Characteristic values

Parameter	Symbol	Conditions	min	typ	max	Unit
Thermal resistance junction to case	$R_{th(j-c)}$	Double-side cooled $F_m = 36...46$ kN			10	K/kW
	$R_{th(j-c)A}$	Anode-side cooled $F_m = 36...46$ kN			18	K/kW
	$R_{th(j-c)C}$	Cathode-side cooled $F_m = 36...46$ kN			22	K/kW
Thermal resistance case to heatsink	$R_{th(c-h)}$	Double-side cooled $F_m = 36...46$ kN			3	K/kW
	$R_{th(c-h)}$	Single-side cooled $F_m = 36...46$ kN			6	K/kW

Analytical function for transient thermal impedance:

$$Z_{th(j-c)}(t) = \sum_{i=1}^n R_{th i} (1 - e^{-t/t_i})$$

i	1	2	3	4
$R_{th i}$ (K/kW)	6.599	2.148	1.011	0.249
τ_i (s)	0.5067	0.0458	0.0054	0.0007

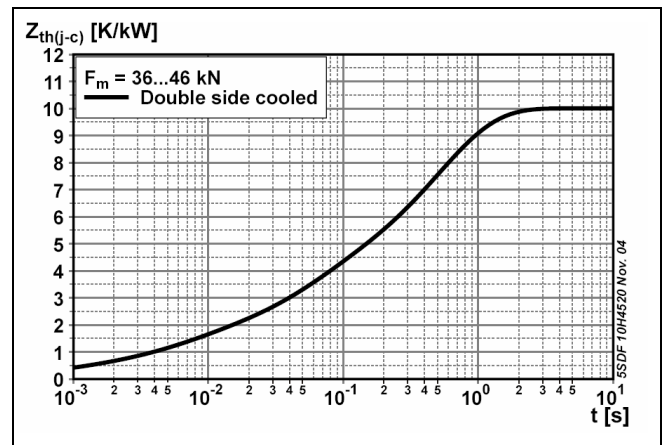

Fig. 1 Transient thermal impedance junction-to-case.

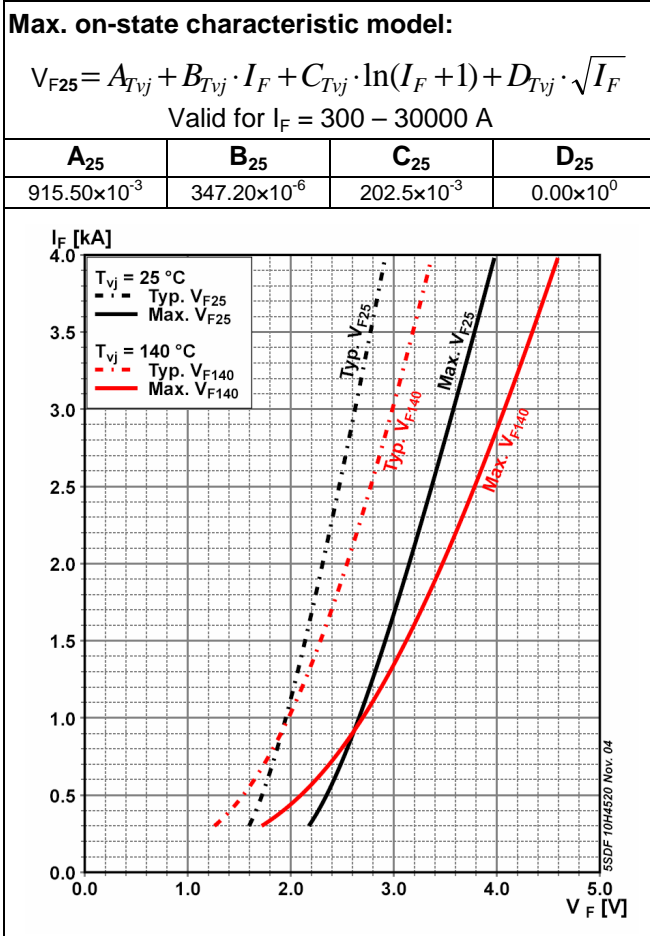

Fig. 2 Max. on-state voltage characteristics

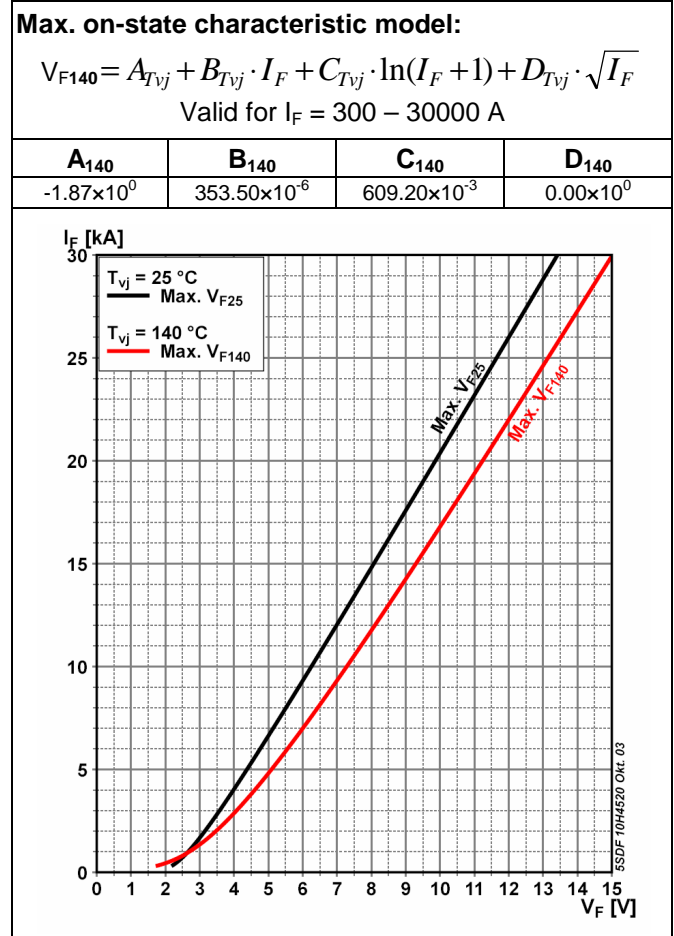

Fig. 3 Max. on-state voltage characteristics

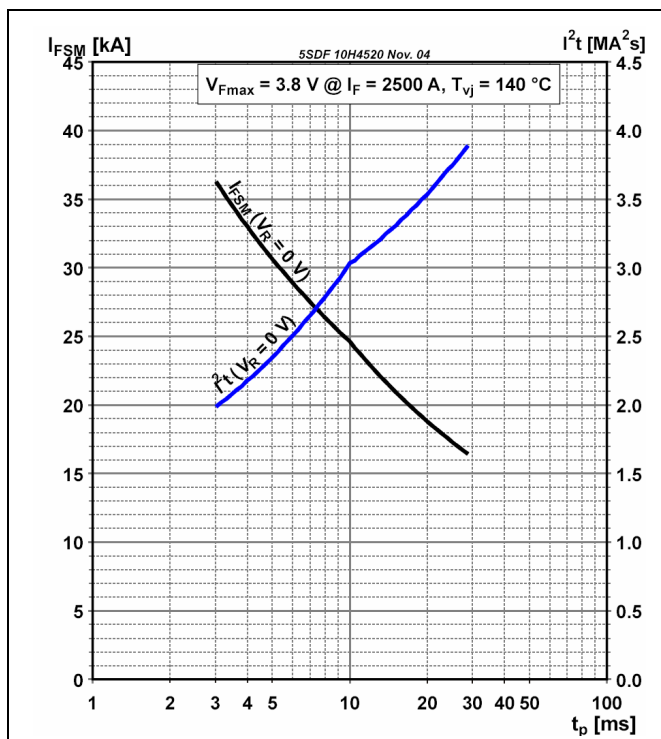

Fig. 4 Surge on-state current vs. pulse length. Half-sine wave.

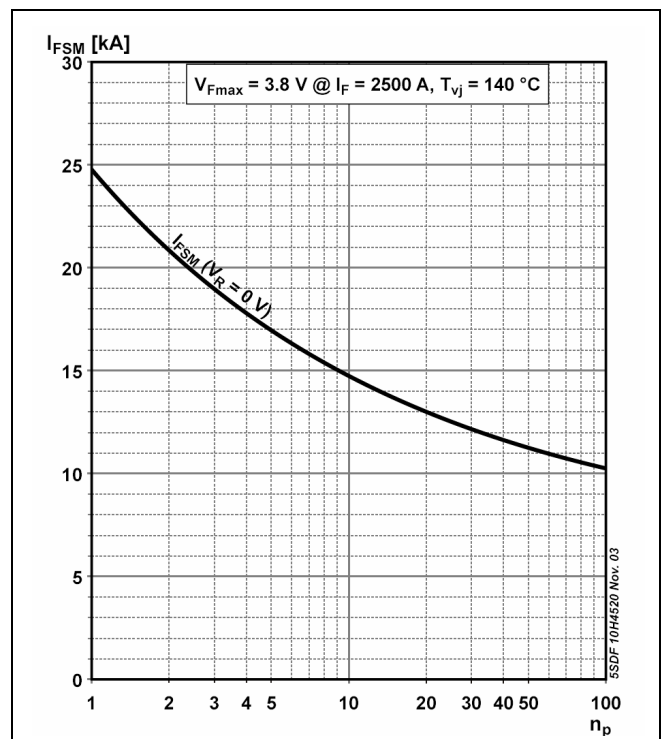

Fig. 5 Surge on-state current vs. number of pulses. Half-sine wave, 10 ms, 50Hz

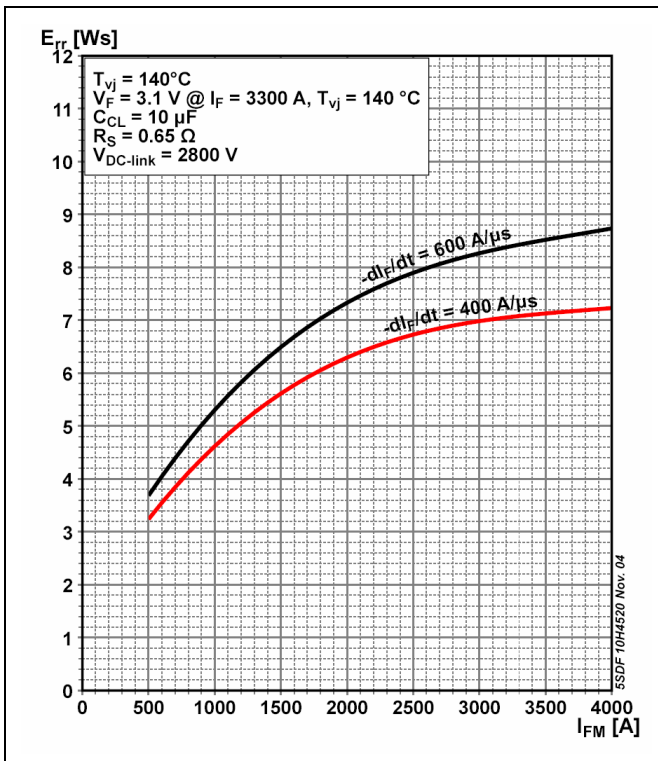

Fig. 6 Upper scatter range of turn-off energy per pulse vs. turn-off current.

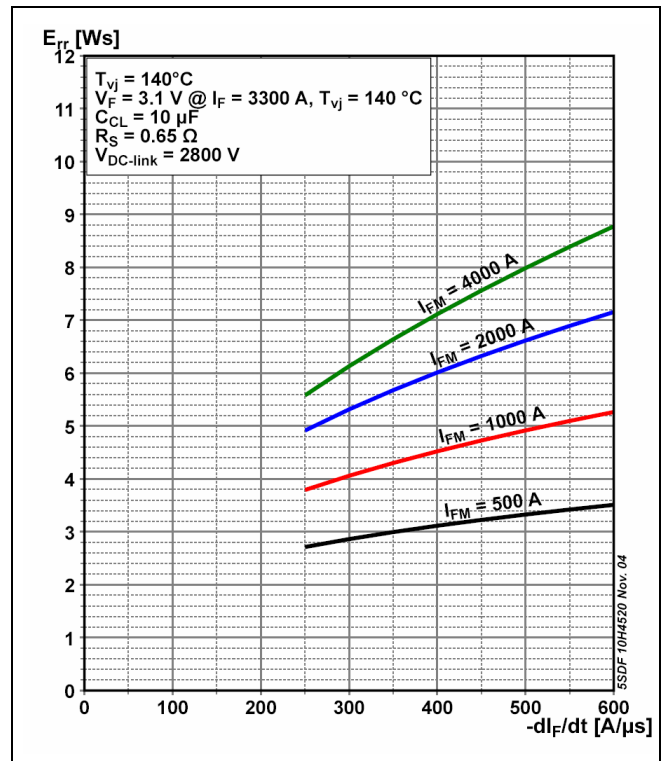

Fig. 7 Upper scatter range of turn-off energy per pulse vs reverse current rise rate.

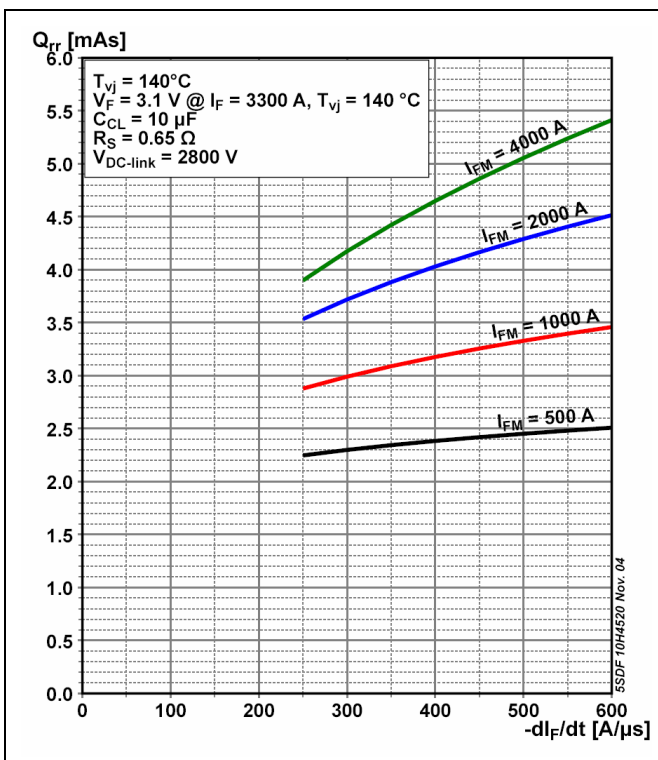

Fig. 8 Upper scatter range of repetitive reverse recovery charge vs reverse current rise rate.

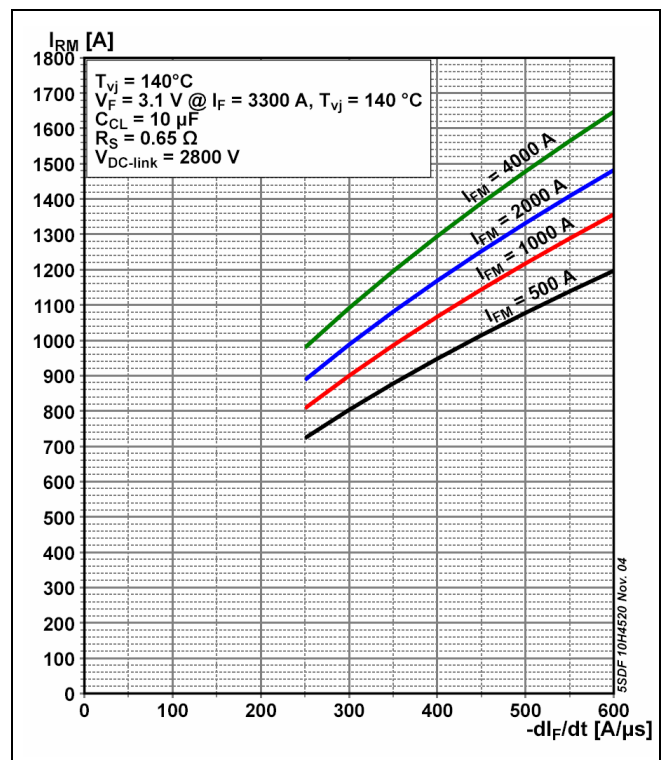

Fig. 9 Upper scatter range of reverse recovery current vs reverse current rise rate.

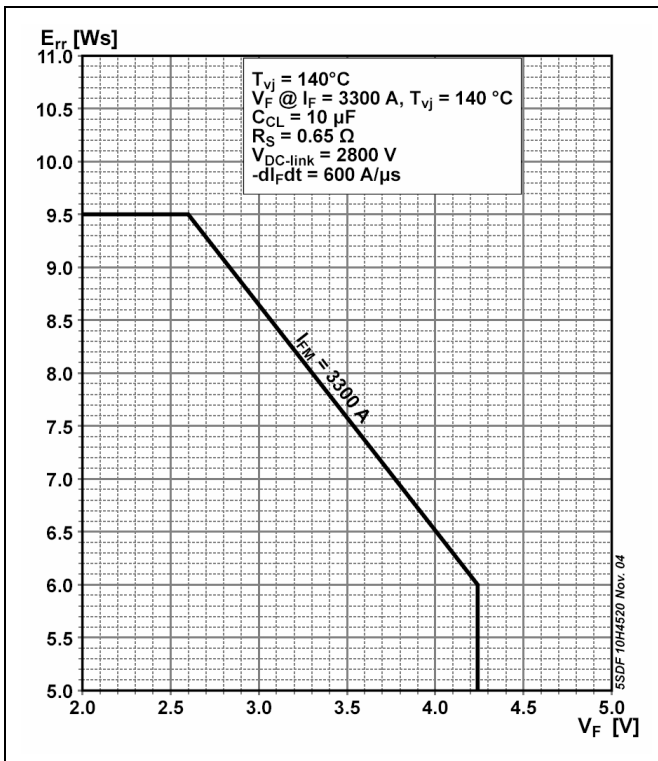

Fig. 10 Max. turn-off energy per pulse vs. on-state voltage.

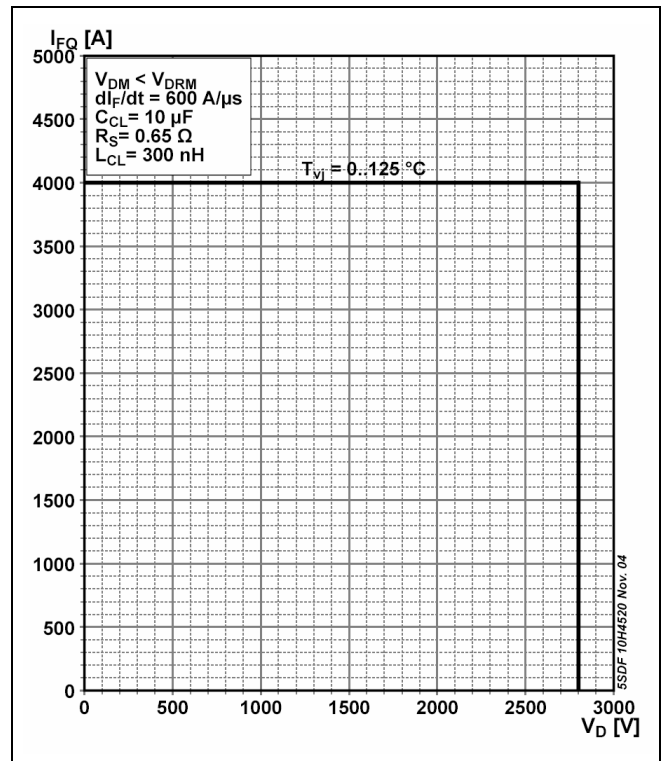

Fig. 11 Diode Safe Operating Area

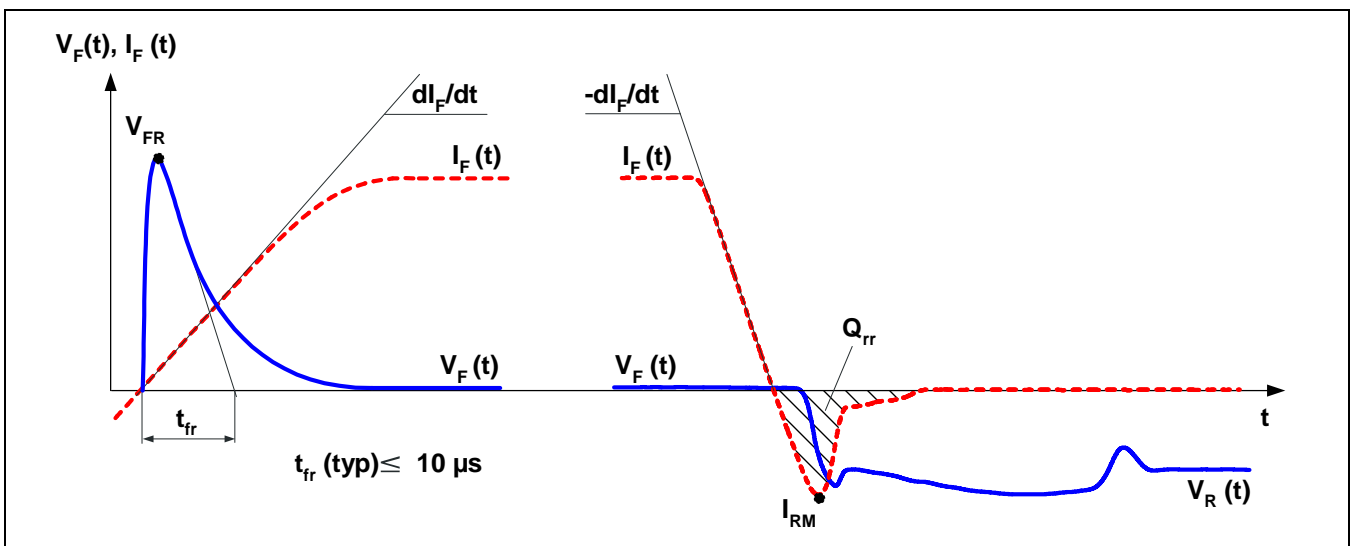

Fig. 12 General current and voltage waveforms.

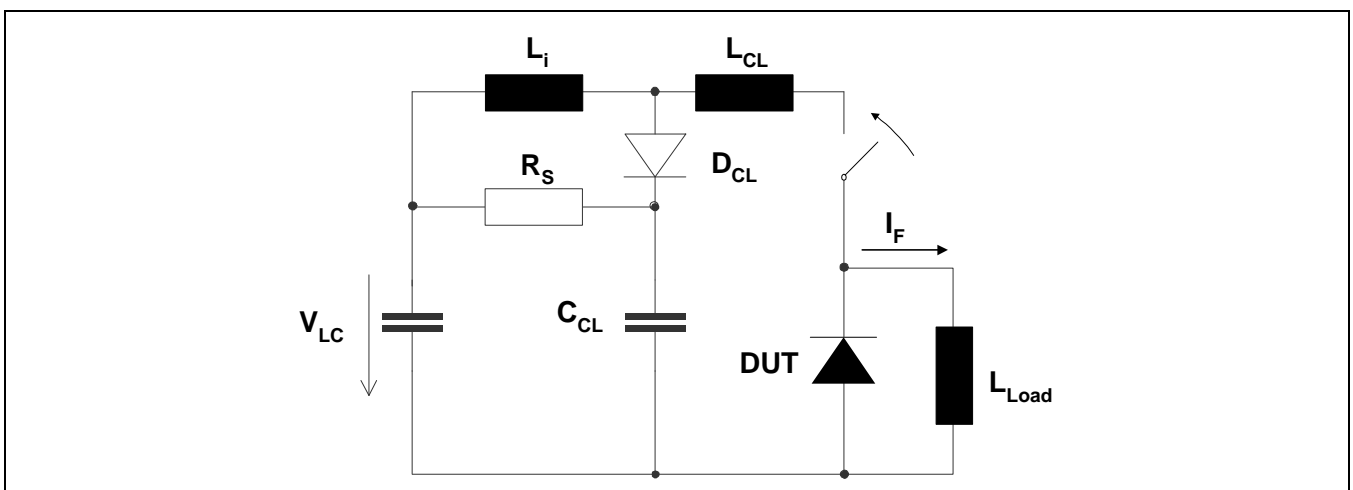

Fig. 13 Test circuit.

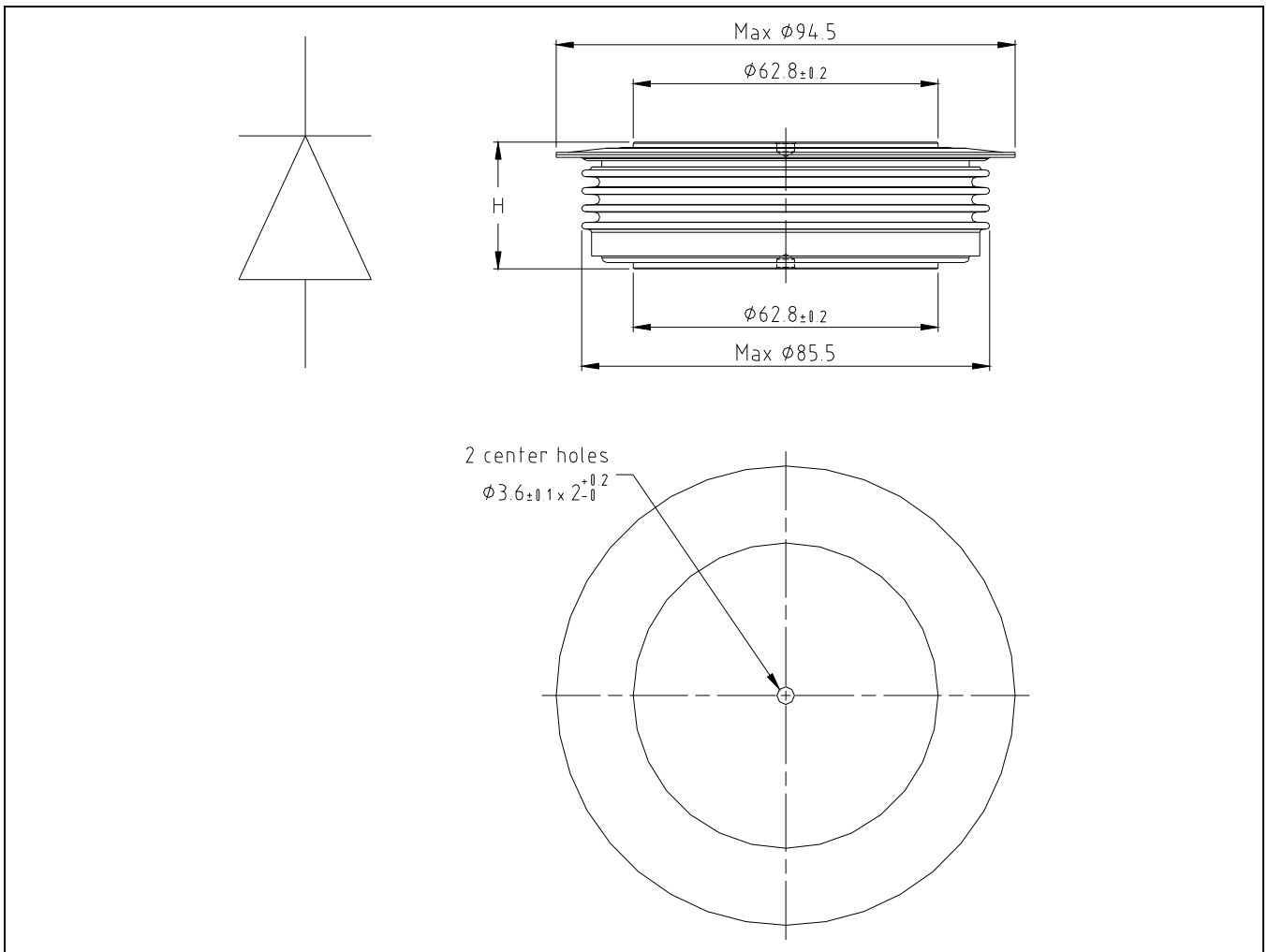

Fig. 14 Outline drawing. All dimensions are in millimeters and represent nominal values unless stated otherwise.

Related application notes:

Doc. Nr	Titel
5SYA 2036	Recommendations regarding mechanical clamping of Press Pack High Power Semiconductors

Please refer to <http://www.abb.com/semiconductors> for actual versions.

ABB Switzerland Ltd, Semiconductors reserves the right to change specifications without notice.

ABB

ABB Switzerland Ltd
Semiconductors
 Fabrikstrasse 3
 CH-5600 Lenzburg, Switzerland

Doc. No. 5SYA1170-00 March 05

Telephone +41 (0)58 586 1419
 Fax +41 (0)58 586 1306
 Email abbsem@ch.abb.com
 Internet www.abb.com/semiconductors