

$V_{RRM}$	=	4500 V
$I_{FAVM}$	=	650 A
$I_{FSM}$	=	16 kA
$V_{F0}$	=	1.4 V
$r_F$	=	1 m $\Omega$
$V_{DClink}$	=	2800 V

## Fast Recovery Diode

# 5SDF 07F4501

Doc. No. 5SYA1107-03 Sep. 01

- Patented free-floating silicon technology
- Low on-state and switching losses
- Optimized for use as freewheeling diode in GTO converters with high DC link voltages
- Standard press-pack housing, hermetically cold-welded
- Cosmic radiation withstand rating

### Blocking

$V_{RRM}$	Repetitive peak reverse voltage	4500 V	Half sine wave, $t_p = 10$ ms, $f = 50$ Hz	
$I_{RRM}$	Repetitive peak reverse current	$\leq 50$ mA	$V_R = V_{RRM}, T_J = 125^\circ\text{C}$	
$V_{DClink}$	Permanent DC voltage for 100 FIT failure rate	2800 V	100% Duty	Ambient cosmic radiation at sea level in open air.
$V_{DClink}$	Permanent DC voltage for 100 FIT failure rate	V	5% Duty	

### Mechanical data (see Fig. 12)

$F_m$	Mounting force	min.	20 kN	
		max.	24 kN	
a	Acceleration: Device unclamped Device clamped		50 m/s <sup>2</sup>	
			200 m/s <sup>2</sup>	
m	Weight		0.46 kg	
$D_s$	Surface creepage distance	$\geq$	33 mm	
$D_a$	Air strike distance	$\geq$	20 mm	

ABB Semiconductors AG reserves the right to change specifications without notice.



**On-state** (see Fig. 2, 3)

$I_{FAVM}$	Max. average on-state current	650 A	Half sine wave, $T_c = 85^\circ\text{C}$	
$I_{FRMS}$	Max. RMS on-state current	1000 A		
$I_{FSM}$	Max. peak non-repetitive surge current	16 kA	$t_p = 10\text{ ms}$	Before surge: $T_c = T_j = 125^\circ\text{C}$
		44 kA	$t_p = 1\text{ ms}$	
$\int I^2 dt$	Max. surge current integral	$1.28 \cdot 10^6\text{ A}^2\text{s}$	$t_p = 10\text{ ms}$	After surge: $V_R \approx 0\text{ V}$
		$0.8 \cdot 10^6\text{ A}^2\text{s}$	$t_p = 1\text{ ms}$	
$V_F$	Forward voltage drop	$\leq 2.7\text{ V}$	$I_F = 1250\text{ A}$	$T_j = 125^\circ\text{C}$
$V_{F0}$	Threshold voltage	1.4 V	Approximation for	
$r_F$	Slope resistance	1 m $\Omega$	$I_F = 400 \dots 2000\text{ A}$	

**Turn-on** (see Fig. 4, 5)

$V_{fr}$	Peak forward recovery voltage	$\leq 74\text{ V}$	$di/dt = 500\text{ A}/\mu\text{s}$ , $T_j = 125^\circ\text{C}$
----------	-------------------------------	--------------------	--

**Turn-off** (see Fig. 6 to 11)

$I_{rr}$	Reverse recovery current	$\leq 600\text{ A}$	$di/dt = 300\text{ A}/\mu\text{s}$ , $I_F = 700\text{ A}$ , $T_j = 125^\circ\text{C}$ , $V_{RM} = 4500\text{ V}$ , $C_S = 3\mu\text{F}$ (GTO snubber circuit)
$Q_{rr}$	Reverse recovery charge	$\leq 1900\text{ }\mu\text{C}$	
$E_{rr}$	Turn-off energy	$\leq 1\text{ J}$	

**Thermal** (see Fig. 1)

$T_j$	Operating junction temperature range	-40...125 $^\circ\text{C}$		
$T_{stg}$	Storage temperature range	-40...125 $^\circ\text{C}$		
$R_{thJC}$	Thermal resistance junction to case	$\leq 40\text{ K/kW}$	Anode side cooled	$F_m = 20 \dots 24\text{ kN}$
		$\leq 40\text{ K/kW}$	Cathode side cooled	
		$\leq 20\text{ K/kW}$	Double side cooled	
$R_{thCH}$	Thermal resistance case to heatsink	$\leq 10\text{ K/kW}$	Single side cooled	
		$\leq 5\text{ K/kW}$	Double side cooled	

Analytical function for transient thermal impedance.

$$Z_{thJC}(t) = \sum_{i=1}^n R_i (1 - e^{-t/\tau_i})$$

i	1	2	3	4
$R_i(\text{K/kW})$	11.83	4.26	1.63	2.28
$\tau_i(\text{s})$	0.432	0.071	0.01	0.0054
$F_m = 20 \dots 24\text{ kN}$ Double side cooled				

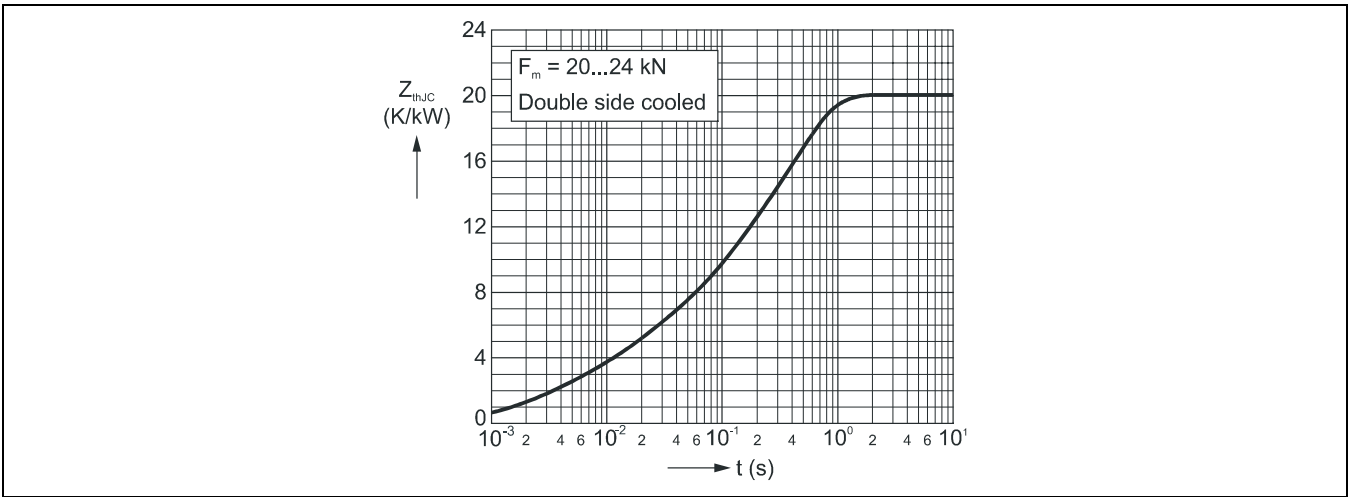

Fig. 1 Transient thermal impedance (junction-to-case) vs. time in analytical and graphical form (max. values).

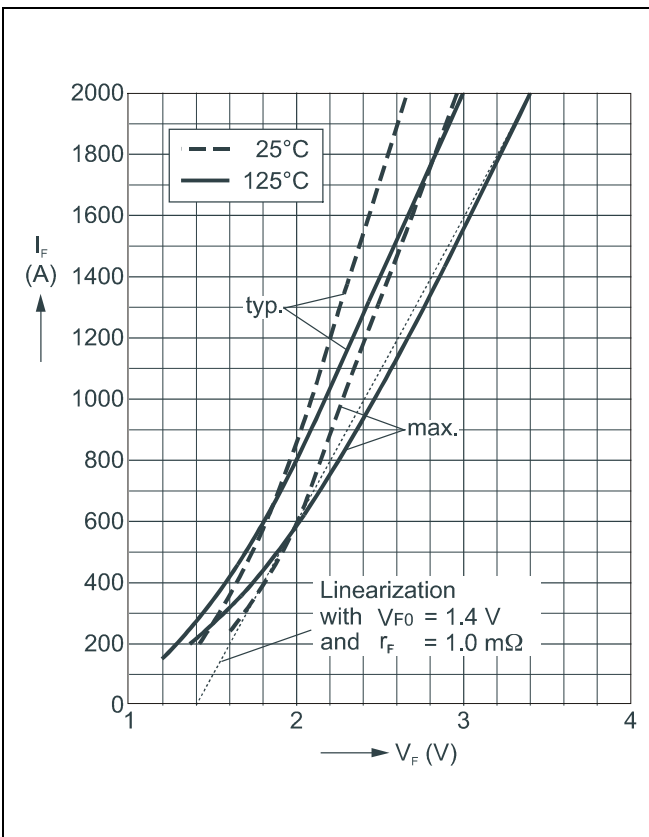

Fig. 2 Forward current vs. forward voltage (typ. and max. values) and linear approximation of max. curve at 125°C.

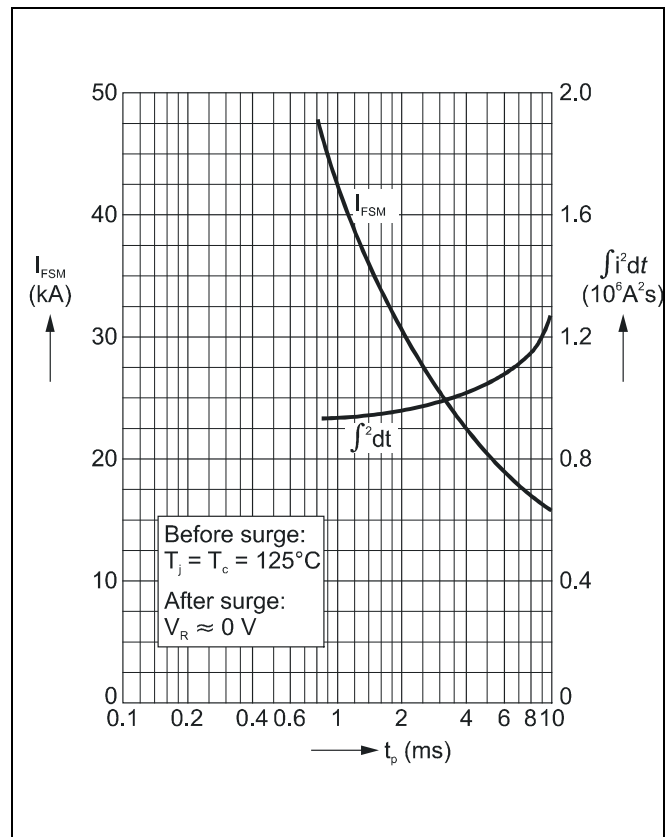

Fig. 3 Surge current and fusing integral vs. pulse width (max. values) for non-repetitive, half-sinusoidal surge current pulses.

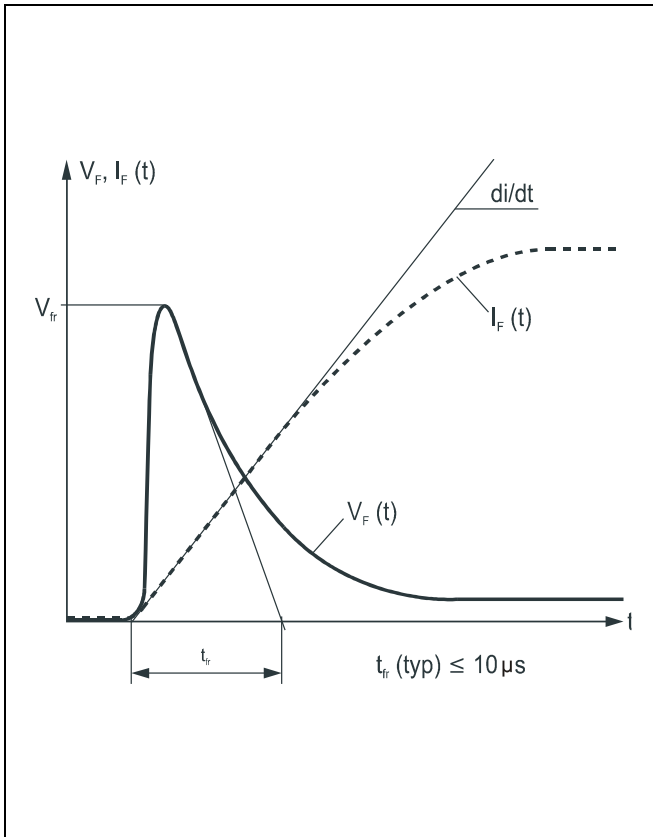

Fig. 4 Typical forward voltage waveform when the diode is turned on with a high di/dt.

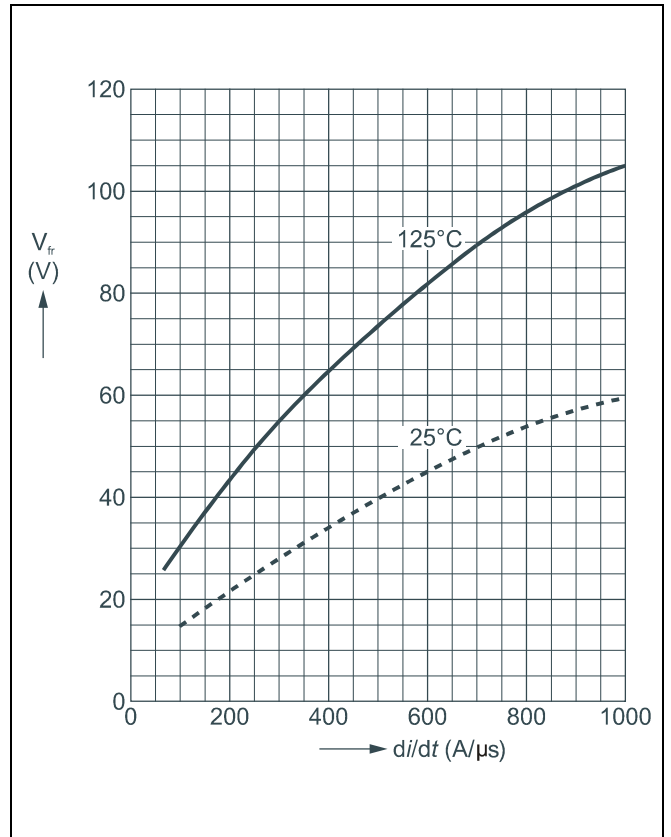

Fig. 5 Forward recovery voltage vs. turn-on di/dt (max. values).

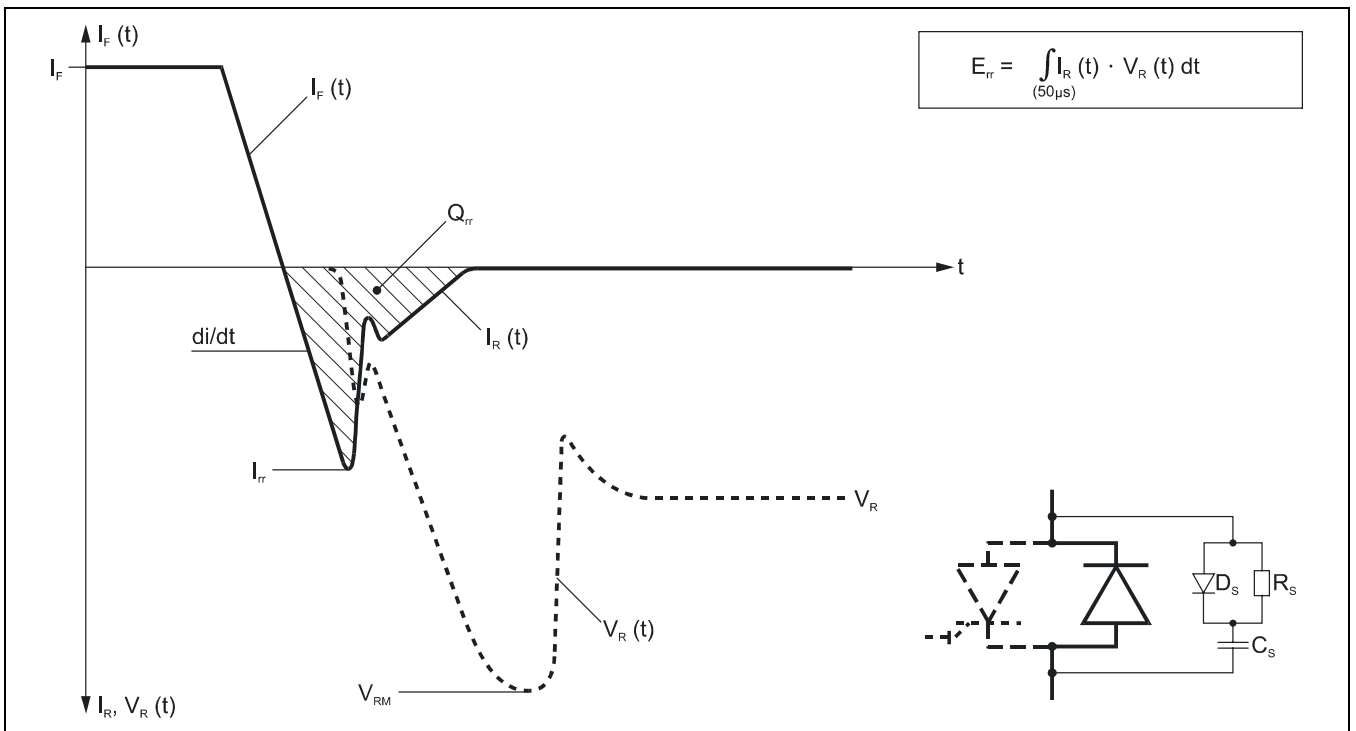

Fig. 6 Typical current and voltage waveforms at turn-off when the diode is connected to an RCD snubber, as often used in GTO circuits.

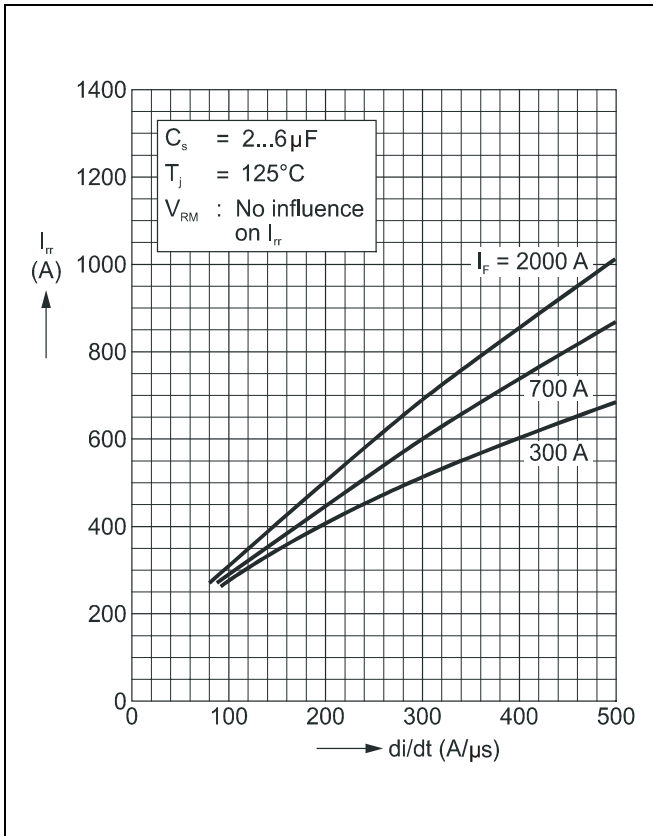

Fig. 7 Reverse recovery current vs. turn off  $di/dt$  (max. values).

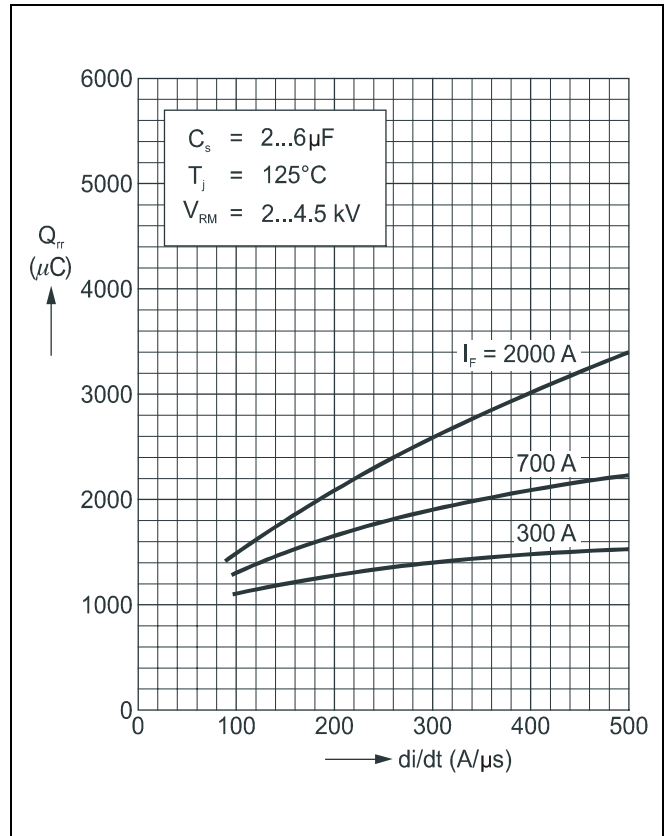

Fig. 8 Reverse recovery charge vs. turn off  $di/dt$  (max. values).

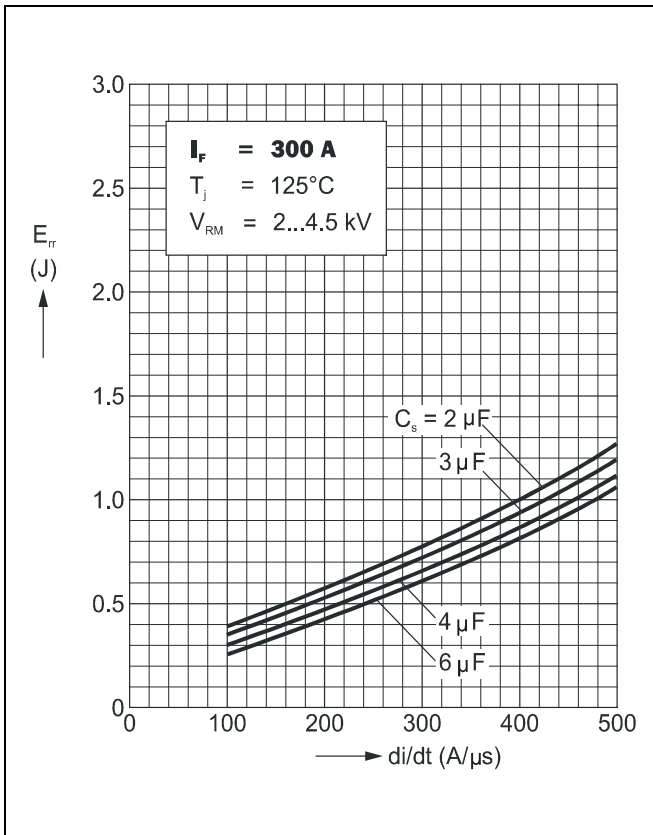

Fig. 9 Turn-off energy vs. turn-off  $di/dt$  for  $I_F = 300$  A (max. values).

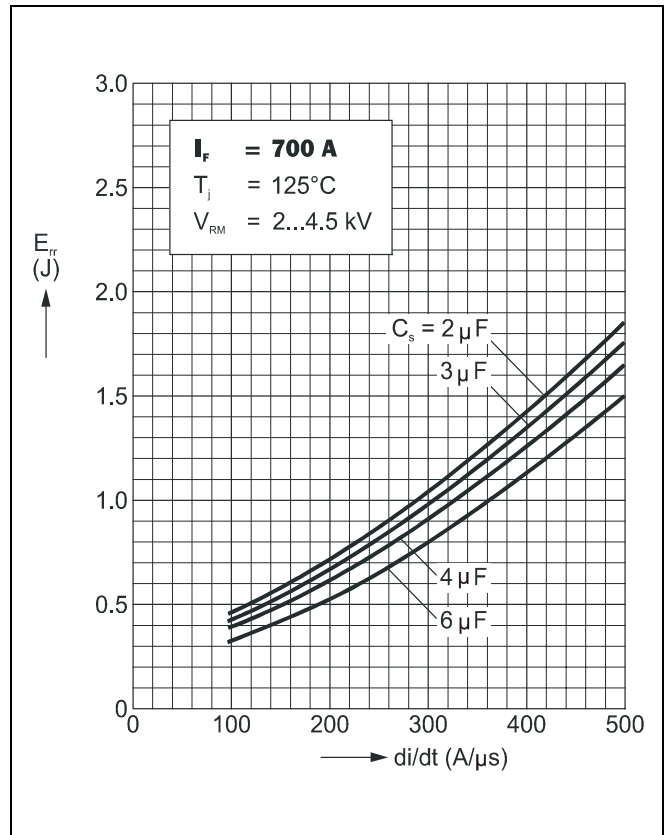

Fig. 10 Turn-off energy vs. turn-off  $di/dt$  for  $I_F = 700$  A (max. values).

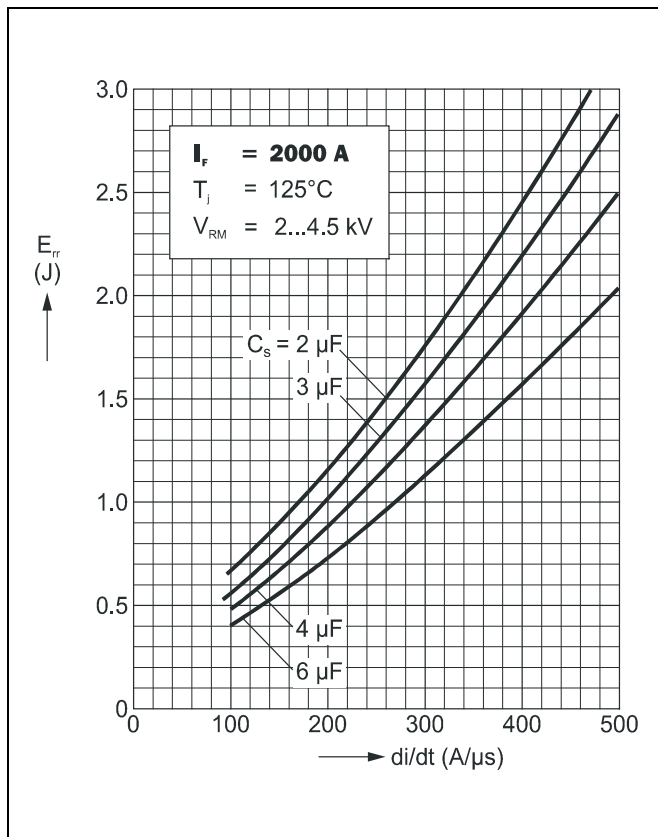

Fig. 11 Turn-off energy vs. turn-off  $di/dt$  for  $I_F = 2000 \text{ A}$  (max. values).

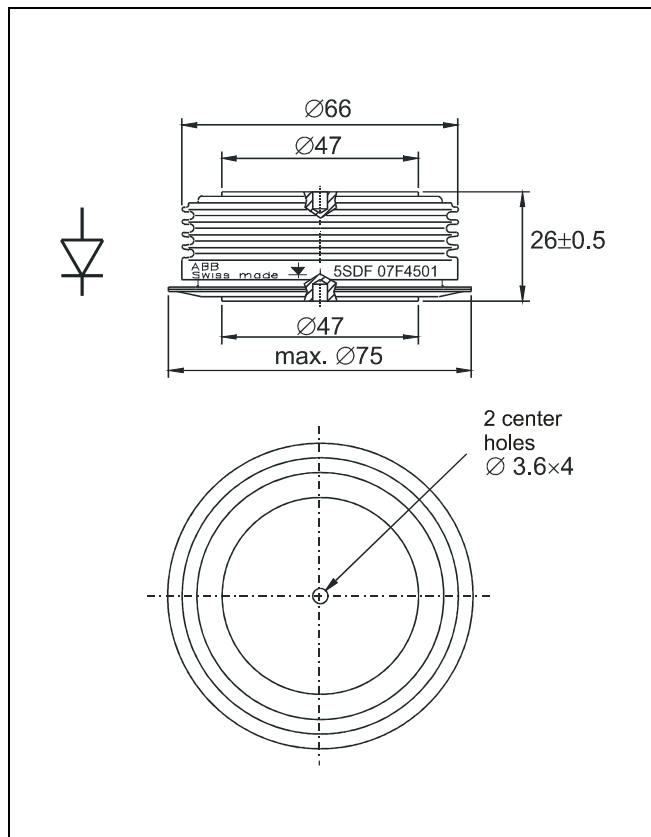

Fig. 12 Outline drawing. All dimensions are in millimeters and represent nominal values unless stated otherwise.

ABB Semiconductors AG reserves the right to change specifications without notice.

# ABB

**ABB Semiconductors AG**  
 Fabrikstrasse 3  
 CH-5600 Lenzburg, Switzerland

Telephone +41 (0)62 888 6419  
 Fax +41 (0)62 888 6306  
 Email [abbsem@ch.abb.com](mailto:abbsem@ch.abb.com)  
 Internet [www.abbsem.com](http://www.abbsem.com)